

SCHEINTECHNICS



Werkzeuge | Tools





1	Hämmer / <i>Hammers</i>	04 - 05
	Zangen / <i>Pliers</i>	06 - 11
2	Scheren / <i>Scissors</i>	12 - 15
	Messer / <i>Knives</i>	16 - 20
3	Handsägen / <i>Handsaws</i>	21
	Bandsägeblätter / <i>Band saw blades</i>	22
4	Beitel / <i>Chisels</i>	23
	Schraubendreher / <i>Screwdrivers</i>	23 - 25
	Schlüssel / <i>Wrenches</i>	26 - 27
5	Messwerkzeuge / <i>Measuring tools</i>	28 - 33
	Sensibilitätsprüfgeräte / <i>Sensitivity testing devices</i>	34
6	Zirkel und Anreisswerkzeuge / <i>Dividers, scribes</i>	35
	Schränkwerkzeuge / <i>Contouring instruments</i>	36
	Feilen und Raspeln / <i>Files and rasps</i>	37 - 39
	Werkzeug für Gipsbearbeitung / <i>Tools for plaster works</i>	40 - 41
7	Locheisen / <i>Hole punches</i>	42 - 43
	Meissel, Körner / <i>Chisels, center punches</i>	43
	Nietenkopfmacher, Schlagsätze / <i>Rivet header, punch sets</i>	44
	Lochnadeln / <i>Drive pin punches</i>	45
8	Spezialwerkzeuge für die Orthopädie-Schuhtechnik / <i>Special tools for orthopaedic shoe technology</i>	46 - 48
9	Werkzeuge für die Nähtechnik / <i>Tools for sewing technology</i>	48 - 49
	Schraubzwingen, Klemmen, Kloben / <i>Screw clamps, clamps, hand vises</i>	50
	Bohrer / <i>Drill bits</i>	51 - 52
10	Gewindebohrer / <i>Taps</i>	52
	Schneidwerkzeuge / <i>Cutting tools</i>	53
	Pinsel, Behälter, Bürsten / <i>Brushes, glue containers</i>	54
11	Schutzausrüstung / <i>Protective equipment</i>	55 - 57
12	Maschinenwerkzeuge / <i>Tools for machines</i>	58 - 67

Hämmer / Hammers



Artikel Article	Beschreibung Description	Artikel-Nr. Code-No.	Hammergewicht/kg head weight/kg	Gewicht/kg Weight/kg
Schlosserhammer	mit poliertem Holzstiel	060000-100	0,100	0,140
		060000-200	0,200	0,270
		060000-300	0,300	0,410
Locksmith's hammer	with polished wood handle	060000-500	0,500	0,610
		060000-600	0,600	0,720
		060000-800	0,800	0,950
		060000-900	1,000	1,170
		060000-950	1,500	1,650

Schlosserhammer mit Schlagkopfsicherung	mit elektroinduktiv angelassenen Schlagkanten	060001-300	0,300	0,500
		060001-400	0,400	0,600
		060001-500	0,500	0,700

Locksmith's hammer with protector for the striking face with electro-inductively tempered striking edges

Ballhammer	Arbeitsfläche blank, mit Stiel, Länge x Breite 600 x 20 mm	060001-000		1,480
------------	--	------------	--	-------

Ball hammer working surface shiny, with handle, length x width 600 x 20 mm

Treibhammer	doppelbahinig, kurze Kopfform, halbkugelig/ flachgewölbt, mit Stiel	060010-250	0,250	0,340
		060010-375	0,375	0,430
		060010-400	0,400	0,510
		060010-500	0,500	0,530

Ball peen hammer double-faced, short head form, one face spherical, one face flat-curved, with handle

Treibhammer	doppelbahinig, lange Kopfform, beide Bahnen kugelförmig, eine Seite groß, eine Seite klein, mit Stiel	060015-250	0,250	0,340
		060015-375	0,375	0,440
		060015-500	0,500	0,520

Ball peen hammer long shaped head, two ball faces of different sizes, with handle

Finnhammer	mit zwei verschieden stark gewölbten Bahnen, mit Stiel	060020-250	0,250	0,330
		060020-375	0,375	0,420
		060020-500	0,500	0,580

Cross peen hammer with two differently curved cross peen faces, with handle

Hämmer /
Hammers

Artikel Article	Beschreibung Description	Artikel-Nr. Code-No.	Hammergewicht/kg head weight/kg	Gewicht/kg Weight/kg
Pick-/Schlacke- hammer <i>Pick/chipping hammer</i>	mit Stiel <i>with handle</i>	060025-000		0,180
Gummihammer/ Schonhammer <i>Replaceable face rubber hammer</i>	zwei verschieden harte, auswechselbare Einsätze, Ø der Schlagfläche 40/45 mm, mit Stiel <i>two heads of different hardness, Ø surface 40/45 mm, with handle</i>	060030-040		0,630
Gummihammer <i>Rubber mallet</i>	Ø der Schlagfläche 65 mm, mit Stiel <i>Ø surface 65 mm, with handle</i>	060035-065		0,520
Schuhmacher- hammer <i>Nail hammer, curved claw</i>	stahlgeschmiedet, vernickelt, mit Stiel <i>steel forged, nickel-plated, with handle</i>	060040-275 060040-350	0,290 0,350	0,370 0,430
Magnethammer <i>Magnetic tack hammer</i>	mit Stiel <i>with handle</i>	060060-000		0,140
Umbughammer <i>Closing hammer</i>	vernickelt, Länge 120 mm <i>nickel-plated, length 120 mm</i>	093485-000		0,330



Zangen /
Pliers



Artikel Article	Beschreibung Description	Artikel-Nr. Code-No.	Länge/mm Length/mm	Gewicht/kg Weight/kg
Beißzange		062600-180	180	0,310
		062600-200	200	0,410

Nipper PVC-coated handles

Rabitzzange	Griffe mit PVC-Überzug	062860-220	220	0,340
-------------	------------------------	------------	-----	-------

Rabitz-nipper PVC-coated handles

Schuhmacher-Beißzange	Griffe mit PVC-Überzug	062865-190	190	0,300
-----------------------	------------------------	------------	-----	-------

Shoemakers' nipper PVC-coated handles

1 Manchesterzange/ Seitenschneider	Griffe mit PVC-Überzug	063540-000	330	0,570
---------------------------------------	------------------------	------------	-----	-------

*Side cutting nipper
Manchester type* PVC-coated handles

2 Manchesterzange gekröpft	Griffe mit PVC-Überzug	063540-010	320	0,570
-------------------------------	------------------------	------------	-----	-------

*Side cutting nipper
Manchester type
offset* PVC-coated handles



Hebelvorschnneider	Griffe lackiert	062670-180	180	0,420
		062670-215	215	0,580
		062670-235	235	0,630

Toggle joint wire nipper coated handles



Artikel Article	Beschreibung Description	Artikel-Nr. Code-No.	Länge/mm Length/mm	Gewicht/kg Weight/kg
Vornschneider	Griffe mit PVC-Überzug	062680-160	160	0,230
		062680-200	200	0,300

End-cutting nipper PVC-coated handles



Kraftseitenschneider	Chromvanadium-Stahl, Griffe mit PVC-Überzug	062690-165	160	0,170
		062690-180	180	0,210

Side cutting nipper Chrome vanadium steel, PVC-coated handles



Kombinationszange	Griffe mit PVC-Überzug	062660-165	160	0,180
		062660-180	180	0,210

Combination plier PVC-coated handles



Flachzange	Griffe mit PVC-Überzug	062605-140	140	0,110
		062605-160	160	0,150

Flat nose plier PVC-coated handles



Langbeck-Flachzange	Griffe mit PVC-Überzug	062610-160	160	0,120
---------------------	------------------------	------------	-----	-------

Long flat nose plier PVC-coated handles



Langschnabelzange	062620-200=Griffe mit PVC-Überzug, 062620-620=verchromt	062620-200	200	0,170	1
		062620-620	200	0,140	2

Long nose plier 062620-200=PVC-coated handles, 062620-620=chrome-plated



Zangen /
Pliers



Artikel Article	Beschreibung Description	Artikel-Nr. Code-No.	Länge/mm Length/mm	Gewicht/kg Weight/kg
Universalzange	062630-250=Griffe mit PVC-Überzug, 062630-240=verchromt	062630-240	250	0,310
		062630-250	250	0,290
Multigrip plier	062630-250=PVC-coated handles, 062630-240=chrome-plated			
Rundzange	Griffe mit PVC-Überzug	062650-140	140	0,090
		062650-160	160	0,140
Round nose plier	PVC-coated handles			
Gripzange		062635-250	250	0,510
Grip wrench				
Fixklemme	Stahlblech, mit Klemmschutz	062855-110	110	0,050
		062855-155	155	0,160
Spring clamp	sheet metal, with clamp protection			
Revolverlochzange	geschmiedet, Griffe mit PVC-Überzug, mit 8 austauschbaren Lochpfeifen: 1,5 / 2 / 2,5 / 3 / 3,5 / 4 / 4,5 / 5 mm Ø	062220-230	245	0,530
Revolving head hole punch	forged, PVC-coated handles, with 8 replaceable punches: 1,5 / 2 / 2,5 / 3 / 3,5 / 4 / 4,5 / 5 mm Ø			
1 Lochpfeife	mit Gewinde, für Revolverlochzange Art.-Nr. 062220-230	062225-010	Ø 1,0 mm	0,006
		062225-015	Ø 1,5 mm	0,006
		062225-020	Ø 2,0 mm	0,006
		062225-025	Ø 2,5 mm	0,006
		062225-030	Ø 3,0 mm	0,006
		062225-035	Ø 3,5 mm	0,006
		062225-040	Ø 4,0 mm	0,006
Punch	threaded, für revolving head hole punch code-no.062220-230	062225-045	Ø 4,5 mm	0,006
		062225-050	Ø 5,0 mm	0,006
2 Amboss	Messing, für Revolverlochzange Art.-Nr. 062220-230	062227-000		0,010
Anvil	brass, for revolving head hole punch code-no.062220-230			

Artikel Article	Beschreibung Description	Artikel-Nr. Code-No.	Länge/mm Length/mm	Gewicht/kg Weight/kg
Revolverlochzange	gepresst, Griffe mit PVC- Überzug, mit 6 Lochpfeifen: 2/2,5/3/3,5/4/5 mm Ø	062222-000	220	0,270
<i>Revolving head hole punch</i>	<i>pressed, PVC-coated handles, with 6 punches: 2/2,5/3/3,5/4/5 mm Ø</i>			
Rahmenauszackzange verchromt		062655-000	200	0,350
<i>Notching plier</i>	<i>chrome-plated</i>			
Ersatzfeder	mit Niete, für Rahmenauszackzange	062656-000		0,005
<i>Replacement spring</i>	<i>with blank, for notching pliers</i>			
Hammerfalzzange	Tuttlinger Form, stahlgeschmiedet, Maulbreite 10 mm, Griffe mit PVC- Überzug	062459-210	220	0,410
<i>Lasting pincer "Tuttlingen"</i>	<i>Tuttlingen type, steel-forged, jaw width 10 mm, PVC-coated handles</i>			
Zwickzange	gebogen, schmal, Maulbreite 8 mm, Griffe mit PVC- Überzug	062479-215	220	0,375
<i>Lasting pincer</i>	<i>curved, narrow, jaw width 8 mm, PVC-coated handles</i>			
Zwickzange	gebogen, breit, Maulbreite 15 mm, Griffe mit PVC- Überzug	062489-210	210	0,390
<i>Lasting pincer</i>	<i>curved, wide, jaw width 15 mm, PVC-coated handles</i>			
Zwickzange	gerade, breit, Maulbreite 17,5 mm	062469-200	200	0,370
<i>Lasting pincer</i>	<i>straight, wide, jaw width 17,5 mm</i>			



Zangen /
Pliers



Artikel Article	Beschreibung Description	Artikel-Nr. Code-No.	Länge/mm Length/mm	Gewicht/kg Weight/kg
Walkzange	Original Schweden- form, verchromt, schmal, gebogen, Maulbreite 7 mm	062490-200	200	0,210
<i>Lasting pincer</i>	<i>original Swedish form, chrome-plated, narrow, curved, jaw width 7 mm</i>			



Walkzange	Original Schweden- form, verchromt, breit, gebogen, Maulbreite 14 mm	062490-230	230	0,410
<i>Lasting pincer</i>	<i>original Swedish form, chrome-plated, wide, curved, jaw width 14 mm</i>			



Rahmenandrückzange	Griffe mit PVC- Überzug	062470-000	210	0,270
<i>Frame pressure plier</i>	<i>PVC-coated handles</i>			



Ballenzange	verchromt, Griffe mit PVC- Überzug	063400-000	400	0,940
<i>Shoe stretcher ball type</i>	<i>chrome-plated, PVC-coated handles</i>			

Zangen/
Pliers

Artikel Article		Artikel-Nr. Code-No.	Länge/mm Length/mm	Gewicht/kg Weight/kg
Ballenzange	lackiert, verstellbar	063402-000	400	0,950

*Shoe stretcher
ball type*

*coated,
with lock bolt*



Kappenheberzange	verchromt	063390-000	420	1,150
-------------------------	-----------	------------	-----	-------

Toe raising plier

chrome-plated



Schmiedezange Flachmaul		065510-310	300	0,550
		065510-510	500	1,200

Blacksmith's tongs flat jaw



Schmiedezange Rundmaul		065510-320	300	0,550
		065510-520	500	1,200

Blacksmith's tongs hollow jaw



Schmiedezange Wolfsmaul		065510-330	300	0,550
		065510-530	500	1,200

Blacksmith's tongs wolf's jaw



Scheren/
Scissors



Artikel Article	Beschreibung Description	Artikel-Nr. Code-No.	Länge/mm Length/mm	Gewicht/kg Weight/kg
Haushaltschere <i>Household scissor</i>	vernickelt <i>nickel-plated</i>	062205-160	160	0,070
		062205-185	185	0,090
		062205-210	210	0,130



Stepschere <i>Backstitch scissor</i>	vernickelt <i>nickel-plated</i>	062193-115	115	0,062
---	------------------------------------	------------	-----	-------

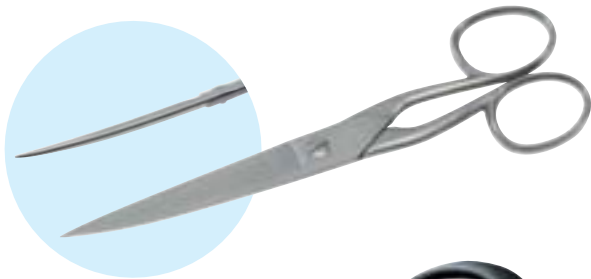

Oberlederschere <i>Leather trimming shear</i>	gebogen <i>curved blade</i>	062210-160	160	0,060
		062210-180	180	0,080



Lederschere <i>Leather shear</i>	gerade, Griffe lackiert, gezahnt <i>straight, coated handles, toothed</i>	062150-225	220	0,370
-------------------------------------	--	------------	-----	-------

Lederschere <i>Leather shear</i>	gerade, Griffe lackiert, ungezahnt <i>straight, coated handles, smooth blade</i>	062150-525	220	0,370
-------------------------------------	---	------------	-----	-------



Lederschere <i>Leather shear</i>	gerade, Griffe mit PVC- Überzug, gezahnt <i>straight, PVC-coated handles, toothed</i>	062152-230	230	0,370
-------------------------------------	---	------------	-----	-------

Lederschere <i>Leather shear</i>	gebogen, Griffe mit PVC- Überzug, gezahnt <i>curved blade, PVC-coated handles, toothed</i>	062152-530	230	0,370
-------------------------------------	--	------------	-----	-------

Scheren/
Scissors

Artikel Article	Beschreibung Description	Artikel-Nr. Code-No.	Länge/mm Length/mm	Gewicht/kg Weight/kg
"IDEAL" Lederschere	Griffe mit PVC-Überzug, gezahnt	062155-000	230	0,420
<i>Leather shear "IDEAL"</i>	<i>PVC-coated handles, toothed</i>			
Schuhmacherschere		062159-180	180	0,140
<i>Leather shear</i>				
Lederschere "Die Beste"	Griffe mit PVC-Überzug, gezahnt	062169-000	230	0,390
<i>Leather shear "The Best"</i>	<i>PVC-coated handles, toothed</i>			
Zuschneideschere	Griffe mit PVC-Überzug, feingezahnt, * =für Linkshänder	062185-210 062185-510*	210 210	0,190 0,190
<i>Trimming scissor</i>	<i>PVC-coated handles, fine-toothed * = for left-handers</i>			
Zuschneideschere	Griffe lackiert * =für Linkshänder	062190-210 062190-235 062190-260 062190-280 062190-315 062190-510* 062190-560*	210 235 260 280 315 210 260	0,180 0,250 0,350 0,410 0,530 0,180 0,260
<i>Trimming scissor</i>	<i>coated handles, * = for left-handers</i>			
Zuschneideschere	Teflon®-beschichtet, mit gezahnter Schneide, Griffe kunststoffüberzogen, speziell für Arbeiten in der Carbontechnik, Schneidenlänge 88 mm	062191-210	210	0,200
<i>Trimming scissor</i>	<i>Teflon®-coated, with serrated blade, plastic-coated handles, specially designed for work with carbon materials, blade length 88 mm</i>			
Allzweckschere	Teflon®-beschichtet, mit gezahnter Schneide, Griffe kunststoffüberzogen, speziell für Arbeiten in der Carbontechnik, Schneidenlänge 75 mm	062192-210	210	0,260
<i>Multi-purpose scissor</i>	<i>Teflon®-coated, with serrated blade, plastic-coated handles, specially designed for work with carbon materials, blade length 75 mm</i>			



Scheren/
Scissors



Artikel Article	Beschreibung Description	Artikel-Nr. Code-No.	Länge/mm Length/mm	Gewicht/kg Weight/kg
Mehrzweckschere <i>Multi-purpose scissor</i>	rostfrei, Griffe aus Kunststoff <i>stainless, plastic handles</i>	062195-210	210	0,090
Zackenschere <i>Pinking shear</i>	vernickelt, Griffe lackiert <i>nickel-plated, coated handles</i>	062200-225	215	0,240
Verbandschere <i>Bandage scissor</i>	"Lister"-Schere, rostfrei <i>"Lister"-type, stainless</i>	062245-090 062245-115 062245-180	90 115 180	0,020 0,040 0,090
Verbandschere <i>Bandage scissor</i>	rostfrei <i>stainless</i>	062255-180	180	0,080
Verbandschere <i>Bandage scissor</i>	vernickelt, aufgebogen, spitz/stumpf <i>nickel-plated, bent un, sharp/blunt</i>	062246-150	150	0,060
Gippschere <i>Cast scissor</i>	leicht, Griffe aus Kunststoff <i>lightweight, plastic handles</i>	062250-180	180	0,060
Gippschere <i>Cast scissor</i>	rostfrei, gezahnt <i>stainless, toothed</i>	062250-210	210	0,170
Gippschere <i>Cast scissor</i>	exzentrisch <i>eccentric</i>	062253-160	190	0,080

Scheren/
Scissors

Artikel Article	Beschreibung Description	Artikel-Nr. Code-No.	Länge/mm Length/mm	Gewicht/kg Weight/kg
Gipsabreisssschere		062252-260	260	0,570
		062252-370	370	1,050
<i>Spreader for plaster casts</i>				
Gipsschere "BRUNS"	rostfrei, untere Schere gezahnt	062251-240	240	0,260
<i>Cast scissor "BRUNS"</i>	<i>stainless, lower blade toothed</i>			
Gipsschere "ESMARCH"	rostfrei	062254-220	220	0,190
<i>Cast scissor "ESMARCH"</i>	<i>stainless</i>			
Figuren-Blechscherer	Spezialstahl, Griffe lackiert	062450-260	260	0,460
<i>Curved sheet metal shears</i>	<i>special steel, coated handles</i>			
"IDEAL"-Blechscherer	für harte Bleche (V2A) bis 1,2 mm	062455-300	260	0,530
<i>Curved sheet metal shears</i>	<i>for hard sheet metal (V2A) up to 1.2 mm</i>			
Hebelblechscherer	zum Schneiden von Blechen und Rundstahl	065001-160	160	12,000
		065001-200	200	21,000
<i>Cutting device</i>	<i>for cutting steel sheet and round steel</i>			
Ersatzmesser für Hebelblechscherer	Ober- und Unter- messer	065003-160	160	0,740
		065003-200	200	0,930
<i>Spare knife for cutting device</i>	<i>upper / lower knife</i>			
Untergestell	für Hebelblechscherer	065004-000		30,000
<i>Lower frame</i>	<i>for cutting device</i>			
Elektro-Handscherer	schneidet Textilien und weiches Leder, Einzel- und Mehrlagenschnitte, 230 V / 0,056 kW	064580-000	230	1,500
<i>Electric hand scissors</i>	<i>for effortless cutting of fabric and soft leather, can cut individual and multiple layers, 230 V / 0,056 kW</i>			
Ersatzmesser	für Elektrohandscherer	064590-006		0,020
<i>Spare knife</i>	<i>for electric hand scissors</i>			



Messer/
Knives

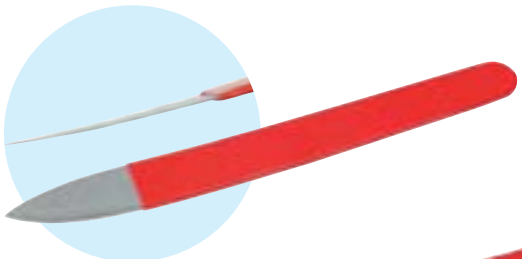
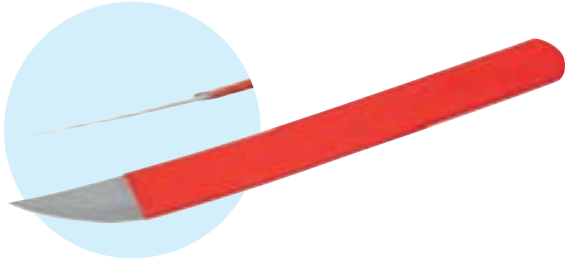

Artikel Article	Beschreibung Description	Artikel-Nr. Code-No.	Länge/mm Length/mm	Gewicht/kg Weight/kg
Schuhmachermesser "TINA"	Norddeutsche Form, Kunststoff überzogen	062100-015	240	0,060
<i>Shoemakers' knife "TINA"</i>	<i>North German shape, plastic-coated</i>			
Schuhmachermesser "TINA"	leicht aufgebogen, Kunststoff überzogen	062100-025	230	0,060
<i>Shoemakers' knife "TINA"</i>	<i>slightly curved, plastic-coated</i>			
Schuhmachermesser "TINA"	gerade, Kunststoff überzogen	062100-035	240	0,060
<i>Shoemakers' knife "TINA"</i>	<i>straight, plastic-coated</i>			
Schuhmachermesser "TINA"	Süddeutsche Form, Kunststoff überzogen	062100-045	270	0,080
<i>Shoemakers' knife "TINA"</i>	<i>South German shape, plastic-coated</i>			
Entgratmesser	für Kunststoffe, mit Heft und Schutzkappe, Klinge auswechselbar	062105-000	160	0,030
<i>Deburring knife</i>	<i>for plastics, with handle and protecting cap, exchangeable blade</i>			
Ersatzklinge Spare blade	für Entgratmesser for deburring knife	062107-000		0,001
Bandagisten- Ledermesser	gebogen	062110-010		0,090
<i>Leather knife</i>	<i>curved</i>			
Bandagisten- Ledermesser	spitz	062110-020		0,090
<i>Leather knife</i>	<i>pointed</i>			
Bandagisten- Ledermesser	schräg	062110-030		0,090
<i>Leather knife</i>	<i>beveled</i>			

Messer/
Knives

Artikel Article	Beschreibung Description	Artikel-Nr. Code-No.	Länge/mm Length/mm	Gewicht/kg Weight/kg
Spezial-Gipsmesser	rostfrei	062115-000	180	0,170

Special plaster knife stainless



Filzmesser	mit Holzgriff	062120-120	240	0,040
------------	---------------	------------	-----	-------

Felt knife wooden handle



Zuschneidemesser "MUNDUS"	mit vernickeltem Metallheft, Klinge stufenlos verstellbar, ohne Abstechnadel	062125-000	160	0,040
------------------------------	--	------------	-----	-------

Utility knife "MUNDUS" with nickel-plated metal handle, blade infinitely adjustable, without cut marking needle



Zuschneidemesser "MUNDUS"	mit vernickeltem Metallheft, Klinge stufenlos verstellbar, mit Abstechnadel	062125-020	170	0,040
------------------------------	---	------------	-----	-------

Utility knife "MUNDUS" with nickel-plated metal handle, blade infinitely adjustable, with marking needle



Zuschneidemesser "KOBITO"	mit Einspanngriff und Abstechnadel, Klinge stufenlos verstellbar	062125-030	180	0,030
------------------------------	--	------------	-----	-------

Utility knife "KOBITO" with clamping handle and cut marking needle, blade infinitely adjustable



Ersatzklinge	für Mundus und Kobito 062125-000 062125-020 062125-030	062127-000		0,010
--------------	---	------------	--	-------

*Spare blade for Mundus and Kobito
062125-000
062125-020
062125-030*



Zuschneidemesser	Klinge verstellbar im Holzheft	062125-100	200	0,090
------------------	--------------------------------	------------	-----	-------

Utility knife blade adjustable wooden handle



Messer/
Knives



Artikel Article	Beschreibung Description	Artikel-Nr. Code-No.	Länge/mm Length/mm	Gewicht/kg Weight/kg
Halbmondmesser	Holzheft mit Messing-zwinge	062130-000	160	0,160
<i>Half-moon head knife</i>	<i>wooden handle with brass collet</i>			
Viertelmondmesser	Holzheft mit Messing-zwinge	062135-000	100	0,100
<i>Quarter circle knife</i>	<i>wooden handle with brass collet</i>			
Zugmesser	Ganzstahl, gebogen	062320-000	250	0,490
<i>Draw knife</i>	<i>tool steel, curved</i>			
Randmesser	gebogene Klinge, *= für Rechtshänder **= für Linkshänder	063470-000* 063470-100**		0,040 0,040
<i>Angle-grip knife</i>	<i>curved blade, *= for right-handers **= for left-handers</i>			
Rollmesser	mit Kunststoffgriff	062108-000	170	0,060
<i>Roller knife</i>	<i>with plastic handle</i>			
Ersatzklinge	für Rollmesser	062109-000		0,014
<i>Spare blade</i>	<i>for rolling fabric cutter</i>			

Messer/
Knives

Artikel Article	Beschreibung Description	Artikel-Nr. Code-No.	Länge/mm Length/mm	Gewicht/kg Weight/kg
Entgrater	mit zwei Klingen, Klingenhalter aus- ziehbar, einsetzbar für Metall und Kunststoff	062243-000	130-230	0,080
<i>Quick change deburring tool</i>	<i>with two blades, extendable blade holder, suitable for metal and plastic</i>			
Ersatzklingen	für Bohrungen in Stahl	062244-010		0,002
<i>Spare blades</i>	<i>for holes in steel</i>			
Ersatzklingen	universell für Metalle	062244-020		0,002
<i>Spare blades</i>	<i>universal for metal</i>			
Ersatzklingen	für Kunststoffe	062244-030		0,002
<i>Spare blades</i>	<i>for plastics</i>			
Ersatzklingen	für Bleche bis 3 mm	062244-040		0,002
<i>Spare blades</i>	<i>for sheets up to 1/8 inch</i>			



Wetzstahl mit Griff		062147-200	300	0,380
<i>Whetsteel with handle</i>				



Ölstein	mittelfein, zum Schärfen aller Werkzeuge für Metall- und Holzbearbeitung, Stähle, Messer, Reibahlen usw., vorzugsweise mit Öl, Petroleum oder Wasser zu verwenden	062140-250	150x50x25	0,660
<i>Combination bench stone</i>	<i>medium grit, for sharpening all tools for metal and wood working, steels, blades, reamers etc., used preferably with oil, petroleum or water</i>			



Riemenschneid- maschine	Messing, mit Messer, Schnittbreite bis 150 mm	062170-150		0,900
<i>Strap cutter</i>	<i>brass, with knife, cut width up to 150 mm</i>			
Ersatzmesser	für Riemenschneid- maschine	062175-170		0,100
<i>Spare knife</i>	<i>for strap cutter</i>			



Messer/
Knives



Innen/
inside



Aussen/
outside



Artikel Article	Beschreibung Description	Artikel-Nr. Code-No.	Länge/mm Length/mm	Gewicht/kg Weight/kg
Rohrabschneider <i>Pipe cutter</i>	für Rohre mit einem Ø von 3 - 35 mm <i>for pipe diameters from 3 - 35 mm</i>	062295-335		0,400
Ersatz-Schneidrad <i>Spare cutting wheel</i>	für Rohrabschneider 062295-335 <i>for pipe cutter 062295-335</i>	062296-000		0,010
Ersatz-Rolle <i>Spare cutting wheel</i>	für Rohrabschneider 062295-335 <i>for pipe cutter 062295-335</i>	062297-000		0,010
Rohrentgrater <i>Tube deburrer</i>	für Innen- und Aussen-entgratung 4 - 32 mm Ø <i>for inside and outside tubes 4 - 32 mm Ø</i>	062293-432		0,030
Kantenzieher <i>Edge scraper</i>	Klinge umsteckbar, mit Heft, Schnittbreite 1 und 3 mm <i>exchangeable blade, with handle, cut width 1 and 3 mm</i>	062240-013		0,060
Kantenzieher <i>Edge scraper</i>	Klinge umsteckbar, mit Heft, Schnittbreite 2 und 4 mm <i>exchangeable blade, with handle, cut width 2 and 4 mm</i>	062240-024		0,060

Handsägen/
Hand saws

Artikel Article	Beschreibung Description	Artikel-Nr. Code-No.	Länge/mm Length/mm	Gewicht/kg Weight/kg
Universal-Taschensäge	Griff allseitig verstellbar, mit 1 Universalsägeblatt, Blattlänge 150 mm	062300-000		0,120
<i>Universal pocket saw</i>	<i>handle moveable to all positions, with 1 universal saw blade, blade length 150 mm</i>			
Ersatz-Sägeblatt <i>Spare hacksaw blade</i>	für Universal-Taschensäge <i>for universal pocket saw</i>	062302-000		0,010
Feinsäge	gerade, mit Holzheft, Blattlänge 250 mm	062305-250		0,320
<i>Back / miter saw</i>	<i>straight, wood handle, blade length 250 mm</i>			
Feinsäge	gekröpft, mit Holzheft, Blattlänge 250 mm	062305-255		0,200
<i>Back / miter saw</i>	<i>offset, wood handle, blade length 250 mm</i>			
Metallsägebogen		062310-100	300	0,790
<i>Hacksaw frame</i>				
Metallsägeblatt	doppelseitig, wolframlegiert	062315-010	300	0,040
<i>Hacksaw blade</i>	<i>double-sided, tungsten alloyed</i>			
Metallsägeblatt	einseitig, HSS, 24 Zähne per Zoll	062315-020	300	0,020
<i>Hacksaw blade</i>	<i>one-sided, high speed steel 24 teeth / inch</i>			
Metallsägeblatt	einseitig, HSS, 24 Zähne per Zoll, für Stahlbearbeitung	062315-030	300	0,020
<i>Hacksaw blade</i>	<i>one-sided, high speed steel 24 teeth / inch, for steel sawing</i>			
Handsäge (Fuchsschwanz)	Blatt aus Elektrostahl, Holzgriff geschlossen, lackiert	062308-350	350	0,310
<i>Black hand saw</i>	<i>electric steel blade, wooden handle closed, coated</i>			



**Bandsägeblätter /
Band saw blades**

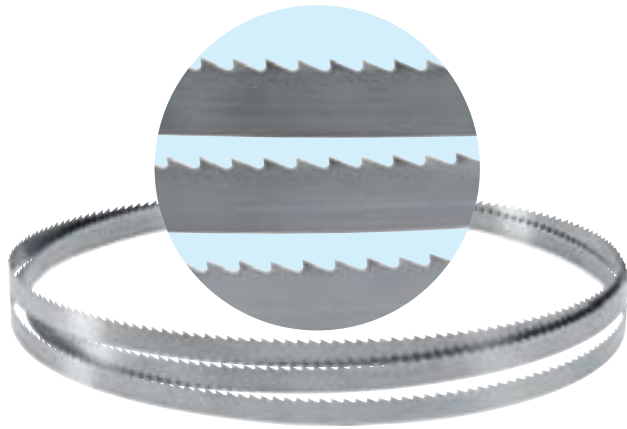

Artikel Article	Beschreibung Description	Artikel-Nr. Code-No.	LxBxStärke/mm LxWxthickness/mm	Gewicht/kg Weight/kg
Bandsägeblatt HOLZ	fertig geschweißt, endlos, Schwedenstahl, 4 Zähne pro Zoll, *=Original-Rolle 50 m	061100-122	2240 x 15 x 0,6	0,090
		061100-132	3200 x 15 x 0,6	0,100
		061100-133	3380 x 15 x 0,6	0,100
		061100-135	3500 x 15 x 0,6	0,100
		061100-199*	50m x 15 x 0,6	3,320

**Band saw blade
WOOD** *welded, endless,
Swedish steel,
4 teeth per inch,
= original coil 50 m

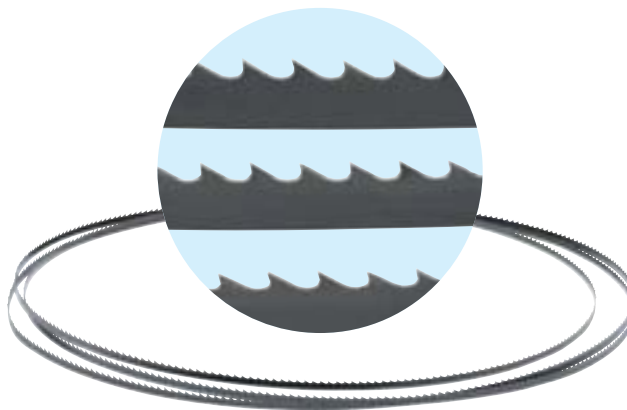

Bandsägeblatt KUNSTSTOFF	Kohlenstoff, zahnvergütet, 6 Zähne pro Zoll, *=Original-Rolle 30 m	061100-222	2240 x 6 x 0,65	0,090
		061100-232	3200 x 6 x 0,65	0,200
		061100-233	3380 x 6 x 0,65	0,115
		061100-235	3500 x 6 x 0,65	0,115
		061100-299*	30m x 6 x 0,65	0,980

**Band saw blade
PLASTIC** *carbon steel, heat treated
6 teeth per inch,
= original coil 30 m

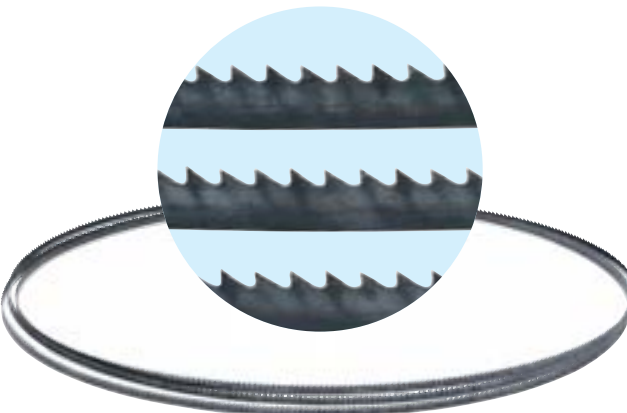

Bandsägeblatt ALU	Kohlenstoff, zahnvergütet, 8 Zähne pro Zoll, *=Original-Rolle 30 m	061100-322	2240 x 6 x 0,65	0,090
		061100-332	3200 x 6 x 0,65	0,090
		061100-333	3380 x 6 x 0,65	0,115
		061100-335	3500 x 6 x 0,65	0,115
		061100-399*	30m x 6 x 0,65	1,130

**Band saw blade
ALU** *carbon steel, heat treated
8 teeth per inch,
= original coil 30 m



Bandsägeblatt VA/EP.	Kohlenstoff, zahnvergütet, 14 Zähne pro Zoll, *=Original-Rolle 30 m	061100-422	2240 x 6 x 0,65	0,090
		061100-432	3200 x 6 x 0,65	0,090
		061100-433	3380 x 6 x 0,65	0,115
		061100-435	3500 x 6 x 0,65	0,115
		061100-499*	30m x 6 x 0,65	1,030

**Band saw blade
VA/EP.** *carbon steel, heat treated
14 teeth per inch,
= original coil 30 m

Beitel/ Chisels

Artikel Article	Beschreibung Description	Artikel-Nr. Code-No.	Breite/mm Width/mm	Gewicht/kg Weight/kg		
Hohlbeitel	CV-Stahl, abgeflachtes Holzheft	062420-006	6	0,080		
		062420-008	8	0,080		
		062420-010	10	0,110		
		062420-012	12	0,130		
		062420-014	14	0,140		
		062420-016	16	0,150		
		062420-018	18	0,180		
Gouge	CV-steel, flattened wooden handle	062420-020	20	0,200		
		062420-026	26	0,230		
		Stechbeitel	CV-Stahl, abgeflachtes Holzheft	062400-006	6	0,080
				062400-008	8	0,090
				062400-010	10	0,110
				062400-012	12	0,110
				062400-014	14	0,110
062400-016	16			0,140		
062400-018	18			0,140		
Flat chisel	CV-steel, flattened wooden handle	062400-020	20	0,170		



Artikel Article	Beschreibung Description	Artikel-Nr. Code-No.	Klingenbreite x Klingenlänge/mm Bit width x bit length/mm	Gewicht/kg Weight/kg
Schraubendreher Schlitz	mit durchgehender Klinge aus CV-Stahl, mit Sechskant- Ansatz, Hartholzheft mit Lederschlagkappe	062505-035	3,5 x 75	0,050
		062505-045	4,5 x 100	0,055
		062505-055	5,5 x 100	0,060
		062505-070	7,0 x 125	0,100
		062505-090	9,0 x 150	0,160
		062505-100	10,0 x 175	0,210
		062505-120	12,0 x 200	0,270
Screwdriver slotted	with continuous blade made of CV steel, with hexagon, hard wood handle with leather hammer head			

Schraubendreher- Satz, Schlitz	7-tlg. von 3,5 - 12 mm, im Hartholzständer	062513-000		1,240
Screwdriver set, slotted	7 pcs., 3,5 - 12 mm, in wooden stand			

Schraubendreher Schlitz	Klinge aus hochlegiertem Molybdän-Vanadium- Spezialstahl, verchromt, mit Sechskantansatz, mit 2-Komponenten-Heft	062501-035	3,5 x 75	0,040
		062501-045	4,5 x 100	0,050
		062501-055	5,5 x 100	0,070
		062501-065	6,5 x 125	0,090
		062501-080	8,0 x 150	0,140
		062501-100	10,0 x 175	0,210
		062501-120	12,0 x 200	0,260
Screwdriver slotted	blade made of high alloyed molybdenum-vanadium special steel, chrome-plated, with hexagon, with 2-component handle			

Schraubendreher- Satz, Schlitz	7-tlg. von 3,5 - 12 mm, im Hartholzständer	062508-000		1,240
Screwdriver set, slotted	7 pcs., 3,5 - 12 mm, in wooden stand			

Schraubendreher/ Screwdrivers



Schraubendreher / Screwdrivers

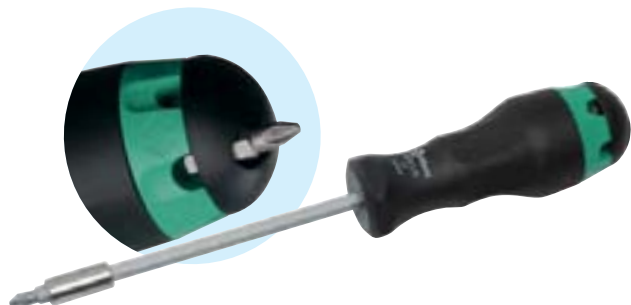

Artikel Article	Beschreibung Description	Artikel-Nr. Code-No.	Klingengröße x Klingenlänge/mm Bit width x bit length/mm	Gewicht/kg Weight/kg
--------------------	-----------------------------	-------------------------	---	-------------------------

Schraubendreher Kreuzschlitz 	mit durchgehender Klinge aus CV-Stahl, mit Sechskant-Ansatz, Hartholzheft mit Lederschlagkappe	062512-001	PH 1 x 80	0,055
		062512-002	PH 2 x 100	0,095
		062512-003	PH 3 x 150	0,165

**Screwdriver
Cross slotted bit** *with continuous CV blade, with hexagon, hard wood handle with leather hammer head*

Schraubendreher-Satz, Kreuzschlitz 	3-tlg. von PH 1 - PH 3, im Holzständer	062514-000		0,500
--	--	------------	--	-------

**Screwdriver set
Cross slotted bits** *3 pcs., PH 1 - PH 3, in wooden stand*

Schraubendreher Kreuzschlitz 	CV-Stahl, verchromt, mit brüniertes Spitze, mit 2-Komponenten-Heft	062518-000	PH 0 x 60	0,030
		062518-001	PH 1 x 80	0,050
		062518-002	PH 2 x 100	0,090
		062518-003	PH 3 x 150	0,150

**Screwdriver
Cross slotted bit** *CV steel, chrome-plated, with bronzed tip, with 2 component handle*

Schraubendreher-Satz, Kreuzschlitz 	4-tlg. von PH 0 - PH 3, im Holzständer	062519-000		0,450
--	--	------------	--	-------

**Screwdriver set
Cross slotted bits** *3 pcs., PH 1 - PH 3, in wooden stand*







Schraubendreher Kreuzschlitz 	CV-Stahl, kurze Form, mit Kunststoffheft	062516-000	PH 1 x 25	0,050
--	--	------------	-----------	-------

**Screwdriver
Cross slotted bit** *CV steel, short version, plastic handle*

Magazin-Schraubendreher 	Heft mit integriertem Bit-Magazin und Aufnahme für 1/4" Bits, Inhalt: 6 Bits	062525-006		0,170
---	--	------------	--	-------

**Magazine
Screwdriver** *Handle with integrated bit magazine, useable for 1/4" bits, contents: 6 bits*

Schraubendreher / Screwdrivers

Artikel Article	Beschreibung Description	Artikel-Nr. Code-No.	Klingengröße x Klingenlänge/mm Bit width x bit length/mm	Gewicht/kg Weight/kg
Kreuzschlitz- Winkel- Schraubendreher 	Klinge aus Chrom- Vanadium-Stahl CV steel	062517-012	PH 1 + PH 2 x 125	0,050
Screwdriver Cross slotted bit				
Kugelkopf- Schraubendreher 	6-kant-Klinge aus CV-Stahl, mit Kunststoffgriff	062530-030 062530-040 062530-050 062530-060 062530-080	3,0 x 100 4,0 x 100 5,0 x 115 6,0 x 140 8,0 x 165	0,030 0,040 0,060 0,100 0,100
Ball end Screwdriver	hexagon CV steel blade, plastic handle			
Sechskant- Schraubendreher 	Klinge aus CV-Stahl, mit Kunststoff-T-Griff und Aufhängeloch	062582-020 062582-030 062582-040 062582-050 062582-060 062582-080 062582-100	2,0 x 100 3,0 x 100 4,0 x 100 5,0 x 100 6,0 x 100 8,0 x 100 10,0 x 100	0,020 0,030 0,050 0,060 0,070 0,090 0,150
Screwdriver Hexagonal	CV steel blade, with plastic T-handle and hole			
Kugelkopf- Sechskant-Winkel- Schraubendreher 	Klinge aus CV-Stahl, mit Kunststoff-Quergriff	062583-030 062583-040 062583-050 062583-060	3,0 x 90 4,0 x 130 5,0 x 130 6,0 x 175	0,060 0,080 0,090 0,140
Ball end hexagon Screwdriver	CV steel, with plastic T-handle			
Sechskant- Schraubendreher- Satz 	8-tlg. in Kunststoffbox, SW 2/2,5/3/4/5/ 6/8/10 mm	062580-010		0,300
Hexagon screwdriver set	8 pcs., in plastic box, mm 2/2,5/3/4/5/ 6/8/10			
Sechskant- Schraubendreher 	CV-Stahl, im Handclip, SW 2,5/3/4/5/6/8 mm	062581-008		0,220
Hexagon screwdriver	CV steel, in hand clip mm 2,5/3/4/5/6/8			
Sechskant- Schraubendreher 	CV-Stahl, im Handclip, SW 2,5/3/4/5/6/8/10 mm	062581-010		0,350
Hexagon screwdriver	CV steel, in hand clip mm 2,5/3/4/5/6/8/10			

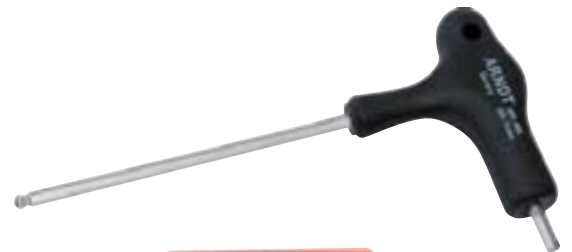

Schlüssel/
Wrenches

Artikel Article	Beschreibung Description	Artikel-Nr. Code-No.	Gewicht/kg Weight/kg
Mutterschlüssel	Stahl, verstellbar, mit Holzheft	062540-000	0,150
<i>Adjustable wrench</i>	<i>steel, adjustable, with wooden handle</i>		
Knieachsschlüssel	verzinkt, mit Holzheft	062560-000	0,210
<i>Knee joint square key</i>	<i>zinc coated, with wooden handle</i>		
Drehmoment-schlüssel	2 - 12 Nm (18-106 lbf.in.) 1/4" Vierkantantrieb, Anzugswert wird am Griffende eingestellt, ablesbar auf Skala, mit Sechskant-Einsatz 3, 4 und 5 mm, Länge 185 mm, in Kunststoff-Koffer	062561-000	0,250
<i>Torque wrench</i>	<i>2 - 12 Nm (18-106 lbf.in.) 1/4" square drive, tightening torque value is set at end of handle and displayed on scale, with hexagon inserts 3, 4 and 5 mm, length 185 mm, in plastic case</i>		
Drehmoment-schlüssel	6 - 30 Nm (50-270 lbf.in.) 1/4" Vierkantantrieb, Anzugswert wird am Griffende eingestellt, ablesbar auf Skala, mit Sechskant-Einsatz 3, 4, 5, 6, 8 und 10 mm, Länge 245 mm, in Kunststoff-Koffer	062562-000	0,580
<i>Torque wrench</i>	<i>6 - 30 Nm (50-270 lbf.in.) 1/4" square drive, tightening torque value is set at end of handle and displayed on scale, with hexagon inserts 3, 4, 5, 6, 8 and 10 mm, length 245 mm, in plastic case</i>		
Sechskant-Einsätze	für Drehmomentschlüssel, 1/4" Vierkantantrieb		max. zul. Nm max. allowed Nm
 <i>Hexagon sockets</i>		062565-003	3 6,6 0,010
		062565-004	4 16 0,010
		062565-005	5 30 0,010
		062565-006	6 52 0,010
		062565-008	8 120 0,010
		062565-010	10 220 0,010

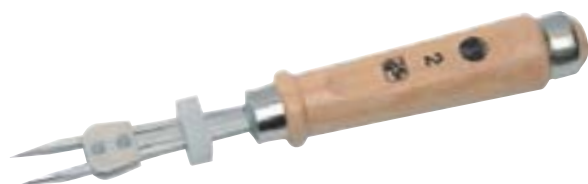

Schlüssel/ Wrenches

Artikel Article	Beschreibung Description	Artikel-Nr. Code-No.	Klingengröße x Klingenlänge/mm Bit width x bit length/mm	Gewicht/kg Weight/kg
Vierkant- Steckschlüssel	schwarz lackiert	062570-150	12,0 x 100	0,390
		062570-500	12,0 x 500	0,900



**Square socket
wrench**

black coated

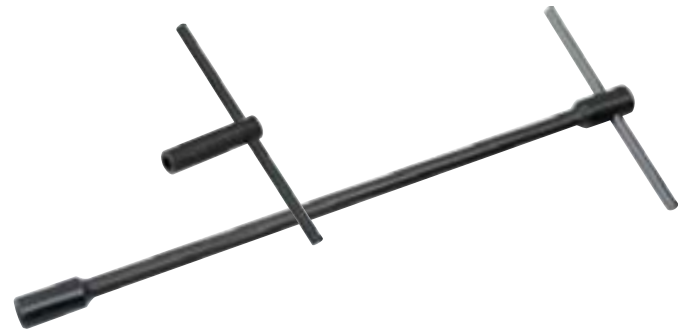

Sechskant- Steckschlüssel	CV-Stahl, vernickelt, mit Kunststoff-T-Griff	062571-060	6,0 x 125	0,070
		062571-070	7,0 x 125	0,090
		062571-080	8,0 x 125	0,100
		062571-100	10,0 x 125	0,120
		062571-110	11,0 x 125	0,130
		062571-120	12,0 x 125	0,130
		062571-130	13,0 x 125	0,130
		062571-140	14,0 x 125	0,130
		062571-170	17,0 x 125	0,130



**Hexagon socket
wrench**

*CV steel, nickel-plated,
with plastic T-handle*



Sechskant- Steckschlüssel	CV-Stahl, vernickelt, mit Kunststoff-T-Griff	062572-060	6,0 x 230	0,110
		062572-070	7,0 x 230	0,120
		062572-080	8,0 x 230	0,130
		062572-100	10,0 x 230	0,140
		062572-130	13,0 x 230	0,170



**Hexagon socket
wrench**

*CV steel, nickel-plated,
with plastic T-handle*



Ring-Maul- Schlüsselsatz	CV-Stahl, Ringkopf abge- winkelt, 12-tlg. in Kunst- stoff-Rolltasche SW 6/7/8/9/10/11/12/ 13/14/17/19/22 mm	060667-622	0,950
-----------------------------	---	------------	-------



**Combination
spanner set**

*CV steel, offset head,
12 pcs. in plastic wallet
mm 6/7/8/9/10/11/12/
13/14/17/19/22*



Doppelmaul- Schlüsselsatz	CV-Stahl, gesenkge- schmiedet, matt verchromt SW 6x7/8x9/10x11/12x13/ 14x15/16x17/18x19/20x22/ 21x23/24x27/25x28/30x32 mm	060760-632	2,250
------------------------------	---	------------	-------



**Double open-
ended wrench set**

*CV steel, drop-forged,
chrome-plated, matt finish
mm 6x7/8x9/10x11/12x13/
14x15/16x17/18x19/20x22/
21x23/24x27/25x28/30x32*



Doppelring- Schlüsselsatz	auf beiden Seiten tief gekröpft für erleichtertes Arbeiten an schwerzugänglichen Stellen. CV-Stahl, matt verchromt SW 6x7/8x9/10x11/12x13/ 14x15/16x17/18x19/20x22 mm	060765-622	1,280
------------------------------	--	------------	-------



Ring spanner set

*deep offset on both ends for easy
working in hard-to-reach areas,
CV steel, with matt-chrome-plated
surface finish
mm 6x7/8x9/10x11/12x13/
14x15/16x17/18x19/20x22*



Messwerkzeuge /
Measuring tools



Artikel Article	Beschreibung Description	Artikel-Nr. Code-No.	Länge/mm Length/mm	Gewicht/kg Weight/kg
Zollstock	aus Leichtmetall* aus Kunststoff** aus Holz***	① 062710-200*	2000	0,160
		② 062711-200**	2000	0,140
		③ 062712-200***	2000	0,180
Folding rule	light metal* plastic** wood***			
Rollbandmaß	Stahl, 1 mm Teilung	062705-200	2000	0,060
Tape rule	steel, 1 mm graduation			
Bandmaß	für Körperumfang- messungen, Gehäuse aus Kunststoff	062706-200	2000	0,060
Tape	for girth measurements, plastic housing			
Schneider- Bandmaß	1 mm Teilung	062700-150	1500	0,030
Tailors' measuring tape	1 mm graduation			
Schuhmacher- Bandmaß	beidseitig mit Maßein- teilung: cm / Stich / englisches Maß	062695-000	600	0,010
Shoemakers' measuring tape	graduation on both sides: cm / Stich / English size			
Stahl-Maßstab	rostfrei, aus Federband- stahl, 1 mm Teilung	062715-150	150	0,010
		062715-300	300	0,020
		062715-500	500	0,040
		062715-100	1000	0,110
Steel rule	stainless, spring band steel, 1mm graduation			

Messwerkzeuge /
Measuring tools

Artikel Article	Beschreibung Description	Artikel-Nr. Code-No.	Länge/mm Length/mm	Gewicht/kg Weight/kg
Stahllineal	rostfrei, mit Facette und Skala, 1 mm Teilung	062740-500	500	0,750
		062740-900	1000	1,500

Steel rule stainless, with chamfer and scale, 1 mm graduation

Werkstattwinkel	Stahl *= mit Anschlag	062750-151	150 x 100	0,210
		062750-201	200 x 130	0,240
		062750-302	300 x 180	0,600
		062750-152*	150 x 100	0,240
Square	steel, *= with stop	062750-203*	200 x 130	0,350
		062750-303*	300 x 180	0,640

Schieblehre	rostfrei, mattverchromt, Schnabellänge 40 mm, Nonius 1/20 - 1/128", mit Momentverstellung, Messbereich 150 mm	062720-150		0,130
--------------------	---	------------	--	-------

Vernier caliper stainless, matt-chrome-plated, jaw length 40 mm, vernier 1/20 - 1/128", with torque adjustment, measuring range 150 mm

Schieblehre	rostfrei, mit Digitalanzeige, Maßgenauigkeit 0,02 mm	062721-150		0,152
--------------------	--	------------	--	-------

Vernier caliper stainless, with digital display, measuring accuracy 0,02 mm

Werkstatt-Schieblehre	mattverchromt, Nonius 1/20 mm, mit langen Schnäbeln, Messbereich 200 mm	062725-200		0,340
------------------------------	---	------------	--	-------

Workshop-Vernier caliper matt-chrome-plated, vernier 1/20 mm, with long jaws, measuring range 200 mm

Werkstatt-Schieblehre	mattverchromt, Nonius 1/10 und 1/20 mm kombiniert, mit abgesetzten Schnabelenden, Messbereich 250 mm, im Holzkasten	062726-250		0,330
------------------------------	---	------------	--	-------

Workshop-Vernier caliper matt-chrome-plated, vernier 1/10 and 1/20 mm combined, with offset jaw ends, measuring range 250 mm, in wooden box



Messwerkzeuge /
Measuring tools

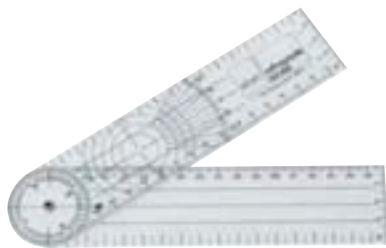

Artikel Article	Beschreibung Description	Artikel-Nr. Code-No.	Gewicht/kg Weight/kg	
Mikrometer	mit Hartmetall-Messflächen, Hebel-feststellung und nachstellbarer Mutter, mit Ratsche, Messbereich 0 - 25 mm im Holzkasten	062730-025	0,210	
Micrometer	with carbide measuring surfaces, lever locking and adjustable nut, with ratchet, measuring range 0 - 25 mm in wooden box			
Dickenmessgerät	Messbereich 0 - 25 mm, Teilung 0,1 mm, Bügeltiefe 50 mm	062735-010	0,130	
Thickness gage	measuring range 0 - 25 mm, graduation 0,1 mm, depth of bow 50 mm			
Zehntelmass	Stahl, mit Messingskala, Messbereich 0 - 15 mm, Teilung 0,1 mm	062770-015	0,060	
Precision gage	steel, with brass scale, measuring range 0 - 15 mm, 0,1 mm graduation			
Diameter	zur Ermittlung von Körpermaßen	Messbereich/mm measuring range/mm		
Diameter gage	for measurement of body sizes	062722-400	400	0,400
		062722-600	600	0,500
Goniometer	aus Kunststoff, Länge 200 mm	062723-200	0,035	
Goniometer	plastic, length 200 mm			
Senklot	Druckguss, mit abschraubbarem Messingkopf	062787-200	0,200	
Plumb bob	die-cast, with unscrewable brass head			

Messwerkzeuge /
Measuring tools

Artikel Article	Beschreibung Description	Artikel-Nr. Code-No.	Länge/mm Length/mm	Gewicht/kg Weight/kg
Reverswinkel	Aluminium, Länge 600 mm	063600-000		0,230

"Reverse" square
aluminum,
length 600 mm



Innenumfang- Messgerät	cm-Teilung, *=für Oberschenkel- Trichter,	032590-000*		1,050
	=für Unterschenkel- Trichter	032590-050		1,050

Inside
circumference
measuring
instrument
cm-graduation,
*=for upper leg cone
**=for lower leg cone



Ersatzband	*=für Code-No. 032590-000	032591-000*	700	0,020
	=für Code-No. 032590-050	032591-050	400	0,020

Replacement band
*=for Code-No.
032590-000
**=for Code-No.
032590-050



Wasserwaage	aus Aluminium	062790-400	400	0,290
-------------	---------------	------------	-----	-------

Spirit level
aluminum



Messwerkzeuge/
Measuring tools



Artikel Article	Beschreibung Description	Artikel-Nr. Code-No.	Länge/mm Length/mm	Gewicht/kg Weight/kg
Beckenwasserwaage mit Pedostat	aus Aluminium, zur Feststellung von Beinlängendifferenzen	032010-000	330	0,260
<i>Pelvic level with pedostat</i>	<i>aluminium, to determine pelvic alignment</i>			
Pedostat-Standfläche	zur Erzielung gleichmäßiger Messergebnisse	032012-000		0,095
<i>Pedostat standing surface</i>	<i>for achieving uniform measuring results</i>			
Beckenwaage, elektronisch	mit Pedostat und Netzteil, eingebauter NiMH-Akku, die Beinlängendifferenz bezogen auf den Beckenbereich wird elektronisch ermittelt und digital angezeigt	032015-000	330	0,370
<i>Pelvic level, electronic</i>	<i>with Pedostat and power supply, integrated NiMH battery, difference in leg length is electronically measured and displayed in relation to the pelvic area</i>			
Distanzplatten-Satz	Kunststoff, 6-teilig, 5/10/15/20/25/30 mm dick, Plattenmaß 320 x 150 mm	R10980051		3,000
<i>Set of spacers</i>	<i>plastic, 6-part, 5/10/15/20/25/30 mm thick, size 320 x 150 mm</i>			
Shorehärte-Messgerät	Messbereich Shore A = in Kunststoffbox	R10980052		1,000
<i>Shore hardness measuring device</i>	<i>measuring range Shore A = foams, supplied in plastic box</i>			

Messwerkzeuge /
Measuring tools

Artikel Article	Beschreibung Description	Artikel-Nr. Code-No.	Länge/mm Length/mm	Gewicht/kg Weight/kg
Beckenzirkel	Edelstahl rostfrei, Messbereich 500 mm	062765-000		0,350

Pelvic dividers stainless steel,
measuring range 500 mm



Modellwinkel	aus Kunststoff, System Fachschule Siebenlehn	063565-000	400	0,100
--------------	---	------------	-----	-------

Special protractor plastic,
type "Siebenlehn"



Heidermass	Kunststoff, zur Schuhgrößenbestimmung	093765-000	335	0,100
------------	--	------------	-----	-------

Foot measuring device "heider" plastic,
for measurement of shoe size



Höhenmessgerät Orthomass	zur Messung von Bettungshöhen, Verkürzungsausgleiche usw.	032060-000	0 - 240	0,580
-----------------------------	---	------------	---------	-------

"Orthomass" height measuring device for measurement of
bedding heights,
shortening compensators etc.

Standunterteil	für Code-No. 032060-000, 032065-000 Satz mit 2 Stück, für den stationären Einsatz			1,410
----------------	---	--	--	-------

Lower part of stand for Code-No. 032060-000,
set with 2 pcs.,
for stationary use



Verkürzungs- Messlehre	Aluminium, geeignet zur "im Schuh"- Messung von Sohlenstärken, Messbereich 0 - 150 mm	032075-000		0,180
---------------------------	--	------------	--	-------

Shortening measuring gage aluminum,
suitable for in-shoe measurement
of sole thicknesses,
measuring range 0 - 150 mm



**Sensibilitätsprüfgeräte /
Sensitivity testing devices**



Artikel Article	Beschreibung Description	Artikel-Nr. Code-No.	Gewicht/kg Weight/kg
Stimmgabel	nach Rydel-Seiffer, zur Prüfung des Vibrations- empfindens	062798-000	0,120
<i>Tuning fork</i>	<i>testing of the sensation of vibration according to Rydel-Seiffer</i>		
Monofilament	zur Oberflächen-Sensibi- litätsmessung bei nicht unmittelbar von Knochen unterlagerter Haut	062797-010	0,007
<i>Monofilament</i>	<i>for superficial sensitivity measurements of skin not directly adjacent to underlying bones</i>		
TipTherm	zur Sensibilitätsmessung kalt/warm im Weichteilgewebe	062796-000	0,056
<i>TipTherm</i>	<i>for cold/warm sensitivity measurements in soft tissue</i>		
Sensibilitäts-Set	inkl. Stimmgabel, Monofilament und TipTherm, in Kunststoffbox	R46279806	0,500
<i>Sensitivity set</i>	<i>incl. tuning fork, Monofilament and TipTherm, in plastic box</i>		

Zirkel und Anreisswerkzeuge / Deviders, scribes

Artikel Article	Beschreibung Description	Artikel-Nr. Code-No.	Länge/mm Length/mm	Gewicht/kg Weight/kg
Bogenzirkel	stahlgeschmiedet, mit gehärteten Spitzen, mit Feststellung	062780-150	150	0,105
		062780-175	175	0,140
		062780-200	200	0,180
Wing dividers	<i>steel forged, with hardened tips, with locking</i>			
Spitzzirkel	stahlgeschmiedet, mit gehärteten Spitzen	062781-150	150	0,090
Pointed dividers	<i>steel forged, with hardened tips</i>			
Aussentaster	Stahl, poliert	062775-150	150	0,080
Outside caliper	<i>steel, polished</i>			
Zirkeltaster	verchromt, mit Stellbogen Messbereich 120 mm	062795-200	200	0,240
Direct reading caliper	<i>chrome-plated, with positioning bow, measuring range 120 mm</i>			
Kopierrädchen	mit gehärteten Stahlnadeln	063610-000	160	0,020
Tracing wheel	<i>with hardened steel needles</i>			
Parallelreisser	ohne Maßeinteilung, Reissnadel schwenk- und drehbar	062755-400	500	1,000
Parallel scriber	<i>without scale division, scriber can be pivoted and rotated</i>			
Reissnadel	CV-Stahl	062760-250	250	0,050
Scriber	CV steel			



Schränkwerkzeuge/ Contouring instruments



Artikel Article	Beschreibung Description	Artikel-Nr. Code-No.	Länge/mm Length/mm	Gewicht/kg Weight/kg
Schränkeisen	CV-Stahl, mit runden Backen Maulweite: 4 + 6 mm* 6 + 8 mm** 7 + 9 mm***	062550-406*	265	0,450
		062550-608**	265	0,450
		062550-709***	265	0,450
Contouring instrument	CV-steel, round opening: 4 + 6 mm* 6 + 8 mm** 7 + 9 mm***			



Schränkeisen	CV-Stahl, mit geraden Backen Maulweite: 4 + 6 mm* 6 + 8 mm** 7 + 9 mm***	092550-406*	250	0,330
		092550-608**	250	0,330
		092550-709***	250	0,330
Contouring instrument	CV-steel, straight opening: 4 + 6 mm* 6 + 8 mm** 7 + 9 mm***			



Flachbiegeeisen	glanzverzinkt	062555-000	500	1,280
Flat contouring instrument	bright zinc coated			



Biegeelement für Flachbiegeeisen	Satz mit 4 Innensechskant-Schrauben und 4 Ersatzscheiben	062556-000		0,080
Bending elements for flat contouring instrument	set with 4 hexagon socket-head screws and 4 replacement disks			

Feilen und Raspeln / Files and rasps

Artikel Article	Beschreibung Description	Artikel-Nr. Code-No.	Länge/mm Length/mm	Gewicht/kg Weight/kg
Flachfeile	ohne Heft Hieb: grob* mittel** fein***	060100-151*	150	0,070
		060100-152**	150	0,070
		060100-153***	150	0,070
		060100-201*	200	0,160
		060100-202**	200	0,160
		060100-203***	200	0,160
Flat file	without handle cut: rough* medium** fine***	060100-251*	250	0,270
		060100-252**	250	0,270
		060100-253***	250	0,270
		060100-301*	300	0,400
		060100-302**	300	0,400
		060100-303***	300	0,400
Halbrundfeile	ohne Heft Hieb: grob* mittel** fein***	060120-151*	150	0,070
		060120-152**	150	0,070
		060120-153***	150	0,070
		060120-201*	200	0,120
		060120-202**	200	0,120
		060120-203***	200	0,120
Half round file	without handle cut: rough* medium** fine***	060120-251*	250	0,250
		060120-252**	250	0,250
		060120-253***	250	0,250
		060120-301*	300	0,410
		060120-302**	300	0,410
		060120-303***	300	0,410
Vierkantfeile	ohne Heft Hieb: grob* mittel** fein***	060140-151*	150	0,040
		060140-152**	150	0,040
		060140-153***	150	0,040
		060140-201*	200	0,090
		060140-202**	200	0,090
		060140-203***	200	0,090
Square file	without handle cut: rough* medium** fine***	060140-251*	250	0,160
		060140-252**	250	0,160
		060140-253***	250	0,160
		060140-301*	300	0,320
		060140-302**	300	0,320
		060140-303***	300	0,320
Dreikantfeile	ohne Heft Hieb: grob* mittel** fein***	060160-151*	150	0,050
		060160-152**	150	0,050
		060160-153***	150	0,050
		060160-201*	200	0,110
		060160-202**	200	0,110
		060160-203***	200	0,110
Triangular file	without handle cut: rough* medium** fine***	060160-251*	250	0,280
		060160-252**	250	0,280
		060160-253***	250	0,280
		060160-301*	300	0,430
		060160-302**	300	0,430
		060160-303***	300	0,430
Rundfeile	ohne Heft Hieb: grob* mittel** fein***	060180-151*	150	0,040
		060180-152**	150	0,040
		060180-153***	150	0,040
		060180-201*	200	0,070
		060180-202**	200	0,070
		060180-203***	200	0,070
Round file	without handle cut: rough* medium** fine***	060180-251*	250	0,150
		060180-252**	250	0,150
		060180-253***	250	0,150
		060180-301*	300	0,270
		060180-302**	300	0,270
		060180-303***	300	0,270
Holzraspel flachstumpf	ohne Heft Hieb: grob	060500-201	200	0,170
		060500-251	250	0,240
Wood rasp flat hand	without handle cut: rough			
Holzraspel halbrund	ohne Heft Hieb: grob* mittel** fein***	060520-151*	150	0,050
		060520-201*	200	0,120
		060520-251*	250	0,270
		060520-301*	300	0,400
		060520-202**	200	0,120
		060520-203***	200	0,120
Wood rasp half round	without handle cut: rough* medium** fine***			

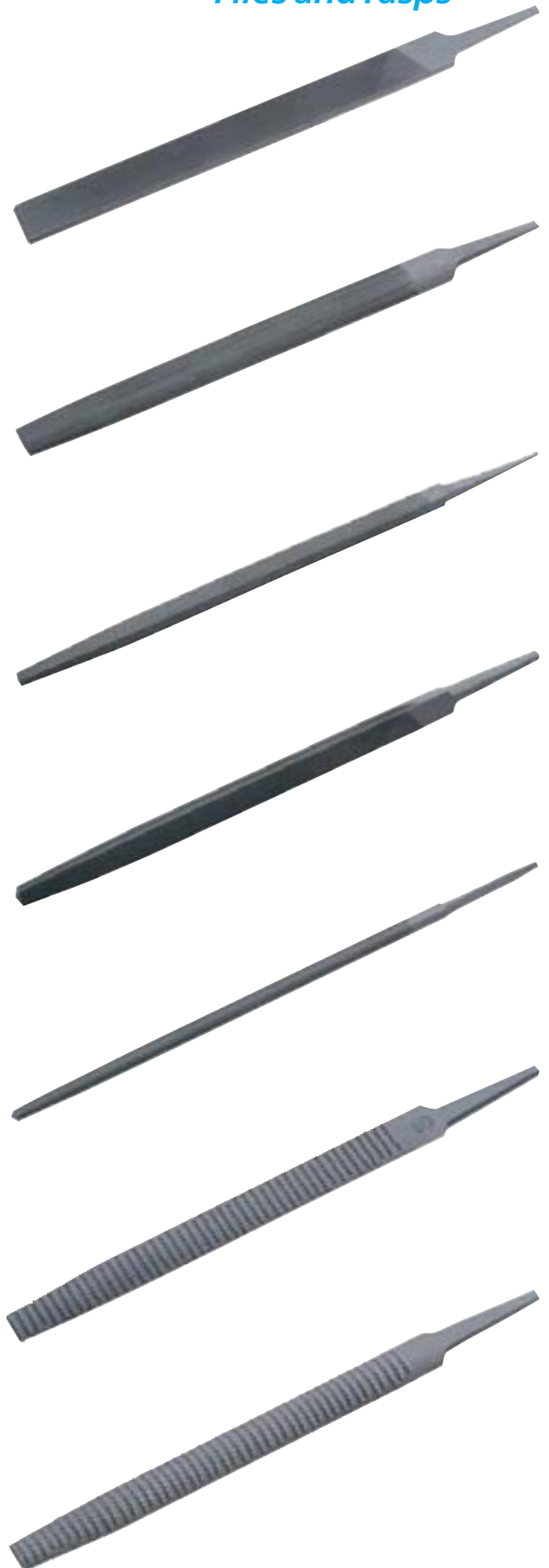

**Feilen und Raspeln /
Files and rasps**

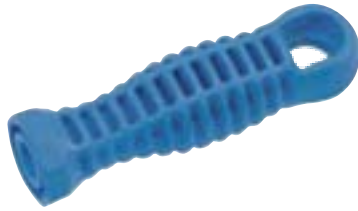

Artikel Article	Beschreibung Description	Artikel-Nr. Code-No.	Länge/mm Length/mm	Gewicht/kg Weight/kg
Holzraspel rund	ohne Heft Hieb: mittel	060545-202	200	0,050
		060545-252	250	0,140
Wood rasp round	without handle cut: middle			
Feilenheft	aus Kunststoff, für Feilenlänge 100 - 150 mm* 200 - 250 mm** 300 - 350 mm***	060380-090*	90	0,020
		060380-110**	110	0,040
		060380-130***	130	0,050
File handle	plastic, for file length 100 - 150 mm* 200 - 250 mm** 300 - 350 mm***			
Schlüsselfeilen- Satz	6-teilig, Hieb: mittel in Kunststofftasche	060250-150	100	0,110
Needle file set	6 pcs., cut: middle in plastic bag			
Absatzkantenfeile	mit Holzheft, für Rechtshänder*, für Linkshänder**	060579-000*	220	0,070
		060579-100**	220	0,070
Heel edge file	wooden handle, for right hander*, for left hander**			
Feilenbürste		060450-230	230	0,080
File brush				
Schuhmacherraspel halbrund	Hieb: normal Breite 27 mm	060590-010	230	0,190
Shoemaker's rasp half round	cut: normal width 27 mm			

Feilen und Raspeln / Files and rasps

Artikel Article	Beschreibung Description	Artikel-Nr. Code-No.	Länge/mm Length/mm	Gewicht/kg Weight/kg	
Schuhmacherraspel Hieb: fein		060595-010	200	0,040	1
		060595-020	200	0,040	2
		060595-030	200	0,030	3
		060595-040	200	0,060	4

Shoemaker's rasp cut: fine



Surformblatt	mit Raspelhalter standard* fein** halbrund*** rund****	060400-010*	250	0,320	1
		060400-020**	250	0,320	2
		060400-030***	250	0,320	3
		060400-040****	250	0,140	4

*Surform blade with handle
standard*
fine**
half round***
round*****



Surformblatt	ohne Raspelhalter standard* fein** halbrund*** rund****	060410-010*	250	0,040	1
		060410-020**	250	0,040	2
		060410-030***	250	0,040	3
		060410-040****	250	0,040	4

*Surform blade without handle
standard*
fine**
half round***
round*****



Surform Raspelhalter	ohne Blatt	060400-050	250	0,280
----------------------	------------	------------	-----	-------

Surform handle without blade



Surform Raspelhalter rund	ohne Blatt	060400-060	250	0,100
---------------------------	------------	------------	-----	-------

Surform handle round without blade



Werkzeuge für Gipsbearbeitung /
Tools for plaster works



Artikel Article	Beschreibung Description	Artikel-Nr. Code-No.	Länge/mm Length/mm	Gewicht/kg Weight/kg
Gipsglätter	mit Kunststoffheft flach* rund**	060390-010*	280	0,220
		060390-020**	300	0,200
Plaster spatula	with plastic handle flat* round**			
Ersatzblatt	für Gipsglätter flach* rund**	060395-010*	280	0,030
		060395-020**	300	0,030
Spare blade	for plaster spatula flat* round**			
Gipsraspel	flach, mit Kunststoffheft	060420-000	250	0,190
Plaster rasp	flat, with plastic handle			
Schleifgitter	zur Oberflächenbe- arbeitung von Gips, Korn 180	060415-180	280 x 230	0,035
Abrasive tool	for surface finishing of plaster, grit 180			
Gips- Modellierisen	Griff kunststoffbeschichtet, Blattbreite: 20 mm* 12 mm** 16 mm***	062830-000*		0,020
		062830-012**		0,020
		062830-016***		0,020
Plaster molding spatula	handle plastic coated, blade width: 20 mm* 12 mm** 16 mm***			

Werkzeuge für Gipsbearbeitung / Tools for plaster works

Artikel Article	Beschreibung Description	Artikel-Nr. Code-No.	Länge/mm Length/mm	Gewicht/kg Weight/kg
Gips-Modellier- Werkzeugsatz	4-teilig, rostfrei, mit Kunststoffheft	062840-004		0,340
<i>Plaster molding tool set</i>	<i>4 pcs., stainless steel, with plastic handle</i>			
Gipsschaber-Satz	5-teilig, rostfrei, mit Holzheft	062850-000		0,270
<i>Plaster scraper set</i>	<i>5 pcs., stainless, with wooden handle</i>			
Gipstrührer	Edelstahl rostfrei	060460-000	500	0,270
<i>Plaster stirrer</i>	<i>stainless steel</i>			
Gipsschaufel	Kunststoff, 500 ml Fassungsvermögen	060470-000	250	0,110
<i>Plaster scoop</i>	<i>plastic, volume 500 ml</i>			
Gipsbecher	aus Gummi	062820-000		0,040
<i>Plaster mixing bowl</i>	<i>made of rubber</i>			
Fettstift	zum Markieren von Gips- modellen, VE = 12 Stück, blau* rot** grün***	063642-001* 063642-002** 063642-003***		0,006 0,006 0,006
<i>Grease pencil</i>	<i>for marking on moist plaster models, packaging unit = 12 pcs., blue* red** green***</i>			
Kopierstift	zum Markieren von Gips- modellen, VE = 12 Stück, blau	063644-000		0,006
<i>Indelible pencil</i>	<i>for marking on moist plaster models, packaging unit = 12 pcs., blue</i>			

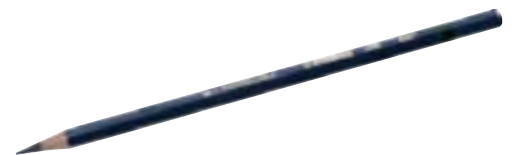

Locheisen / Hole punches

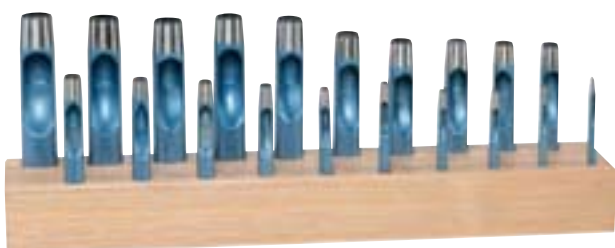
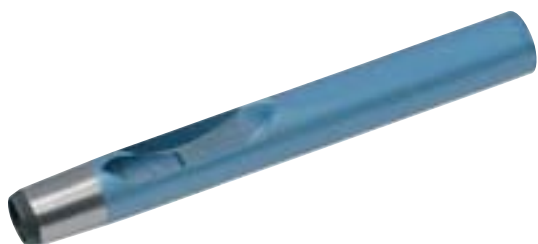

Artikel Article	Beschreibung Description	Artikel-Nr. Code-No.	Ø /mm	Gewicht/kg Weight/kg
Locheisen	Werkzeugstahl, einbrennlackiert, mit rundem Schaft	060800-001	1	0,020
		060800-002	2	0,020
		060800-025	2,5	0,020
		060800-003	3	0,020
		060800-035	3,5	0,030
		060800-004	4	0,030
		060800-005	5	0,030
		060800-006	6	0,050
		060800-007	7	0,060
		060800-008	8	0,070
		060800-009	9	0,080
		060800-010	10	0,090
		060800-011	11	0,110
		060800-012	12	0,140
		060800-013	13	0,160
		060800-014	14	0,180
		060800-015	15	0,190
		060800-016	16	0,230
		060800-017	17	0,280
		060800-018	18	0,320
		060800-019	19	0,350
		060800-020	20	0,370
		060800-022	22	0,440
		060800-025	25	0,610

Locheisensatz	20-teilig, im Holzständer	060860-010	1 - 20	3,750
----------------------	------------------------------	------------	--------	-------

Hole punches set 20 pcs.,
in wooden stand

Locheisensatz	12-teilig, in Kunststofftasche	060805-000	2 - 19	1,400
----------------------	-----------------------------------	------------	--------	-------

Hole punches set 12 pcs.,
in plastic case

Henkelocheisen	Werkzeugstahl, einbrennlackiert, mit Vierkant-Schaft	060830-002	2	0,040
		060830-003	3	0,040
		060830-004	4	0,040
		060830-005	5	0,060
		060830-006	6	0,060
		060830-007	7	0,060
		060830-008	8	0,080
		060830-009	9	0,080
		060830-010	10	0,080
		060830-011	11	0,110
		060830-012	12	0,110
		060830-013	13	0,110
		060830-014	14	0,140
		060830-015	15	0,140
		060830-016	16	0,140
		060830-017	17	0,140
		060830-018	18	0,190
		060830-019	19	0,190
		060830-020	20	0,190
		060830-022	22	0,270
		060830-024	24	0,350
		060830-025	25	0,350
		060830-030	30	0,510
		060830-035	35	0,560
		060830-040	40	0,760

Henkelocheisen-Satz	17-teilig, im Holzständer	060871-000	2 - 25	2,960
----------------------------	------------------------------	------------	--------	-------

Arch punches set 17 pcs.,
in wooden stand

Locheisen, Meissel, Körner / Hole punches, chisel, center punch

Artikel Article	Beschreibung Description	Artikel-Nr. Code-No.	Länge x Breite /mm Length x width /mm	Gewicht/kg Weight/kg
Kappenlocheisen	Werkzeugstahl, einbrennlackiert, mit Vierkant-Schaft	060880-123	12 x 3	0,110
		060880-153	15 x 3	0,120
		060880-183	18 x 3	0,130
		060880-204	20 x 4	0,170
		060880-224	22 x 4	0,180
Oblong arch punches	steel, enamelled, with square shaft			
Knopflocheisen	Werkzeugstahl, einbrennlackiert, mit Vierkant-Schaft	060890-210	10 x 2	0,060
		060890-312	12 x 3	0,060
		060890-412	12 x 4	0,070
		060890-512	12 x 5	0,090
Strap punches	steel, enamelled, with square shaft			
Splintentreibersatz	CV-Stahl, 6-teilig, Ø 3, 4, 5, 6, 7, 8 mm, Länge 150 mm in Metallkassette	062330-006		0,830
Pin punch set	CV steel, Ø 3, 4, 5, 6, 7, 8 mm, length 150 mm in metal case			
Durchschläger	CV-Stahl, lackiert	062365-001	Ø 1 mm	0,080
		062365-002	Ø 2 mm	0,080
		062365-003	Ø 3 mm	0,090
		062365-004	Ø 4 mm	0,090
Drift punches	CV steel, coated			
Flachmeissel	CV-Stahl, lackiert	062380-150	150	0,180
		062380-175	175	0,260
Flat chisel	CV steel, coated			
Werkzeugsatz	CV-Stahl, 6-teilig, im Holzständer, mit 1 Körner, je 1 Durchschläger 2 und 4 mm, je 2 Flachmeissel 12 und 16 mm breit, 1 Kreuzmeissel 5 mm breit	062375-006		0,620
Punch and chisel set	CV steel, 6 pcs., in wooden stand, with 1 pcs. center punch, drift punch each 2 and 4 mm, flat chisel each 12 and 16 mm, cross-cut chisel 5 mm			
Körner	CV-Stahl, lackiert	062370-000	120	0,090
Center punch	CV steel, coated			



Nietenkopfmacher, Schlagsätze/ Rivet header, punch sets



Artikel Article	Beschreibung Description	Artikel-Nr. Code-No.	Länge /mm Length /mm	Gewicht/kg Weight/kg
Automatik-Körner	Auslösung erfolgt durch Drücken mit der Hand, Körnerspitze auswechselbar	062372-001	130	0,080

Automatic center punch Triggered trough hand pressure, replaceable point

Ersatzspitze für Automatik-Körner	Werkzeugstahl	062373-001	50	0,010
--	---------------	-------------------	----	-------

Spare point for automatic center punch tool steel

Nietenzieher	CV-Stahl, lackiert, mm = Nietenschaftsdurchmesser	062340-002	2	0,060
		062340-003	3	0,070
		062340-004	4	0,090
		062340-005	5	0,100
		062340-006	6	0,120

Rivet setter CV steel, coated, mm = Ø of shaft

Nietenkopfmacher	CV-Stahl, brüniert, mm = Nietenschaftsdurchmesser	062350-002	2	0,100
		062350-003	3	0,100
		062350-004	4	0,100
		062350-005	5	0,100
		062350-006	6	0,110

Rivet header CV steel, burnished, mm = Ø of shaft

Nietenkopfmacher für Hohnieten	CV-Stahl, brüniert, für Hohnieten bis 13 mm Kopfdurchmesser	062360-000		0,110
---------------------------------------	---	-------------------	--	-------

Rivet header punch CV steel, burnished, for tubular rivetes up to 13 mm Ø of head

Stahlbuchstaben-Satz	A - Z, 27-teilig, in Kunststoffbox, mm = Buchstabenhöhe	060900-003	3	0,500
		060900-004	4	0,510
		060900-006	6	1,270
		060900-008	8	2,480

Letter die set A - Z, 27 pcs., in plastic box, mm = height of letters

Stahlzahlen-Satz	0 - 9, 9-teilig, in Kunststoffbox, mm = Zahlenhöhe	060920-003	3	0,180
		060920-004	4	0,380
		060920-006	6	0,520
		060920-008	8	0,840

Number die set 0 - 9, 9 pcs., in plastic box, mm = height of figures

Stahlbuchstaben "R" und "L"	Stahl, gehärtet, mm = Buchstabenhöhe	R = 060930-106	6	0,060
		R = 060930-108	8	0,080
		L = 060930-206	6	0,060
		L = 060930-208	8	0,080

Letter dies "R" and "L" steel, hardened, mm = height of letters



Lochnadeln / Drive pin punches

Artikel Article	Beschreibung Description	Artikel-Nr. Code-No.	Länge /mm Length /mm	Gewicht/kg Weight/kg
Lochnadel	rund, vernickelt, System 0, für Schaftgestaltung		Größe / size	
		063545-001	0	0,002
		063545-010	1	0,002
		063545-020	2	0,002
		063545-030	3	0,002
		063545-040	4	0,002
		063545-050	5	0,002
		063545-060	6	0,002
		063545-070	7	0,002
		063545-080	8	0,002
		063545-090	9	0,002
		063545-100	10	0,002
		063545-110	11	0,002
		063545-120	12	0,002
		063545-130	13	0,002
		063545-140	14	0,002
063545-150	15	0,002		
063545-160	16	0,002		
Drive pin punch	round, nickel-plated, system 0, for shaft design			
		063545-001	0	0,002
		063545-010	1	0,002
		063545-020	2	0,002
		063545-030	3	0,002
		063545-040	4	0,002
		063545-050	5	0,002
		063545-060	6	0,002
		063545-070	7	0,002
		063545-080	8	0,002
		063545-090	9	0,002
		063545-100	10	0,002
		063545-110	11	0,002
		063545-120	12	0,002
		063545-130	13	0,002
		063545-140	14	0,002
063545-150	15	0,002		
063545-160	16	0,002		

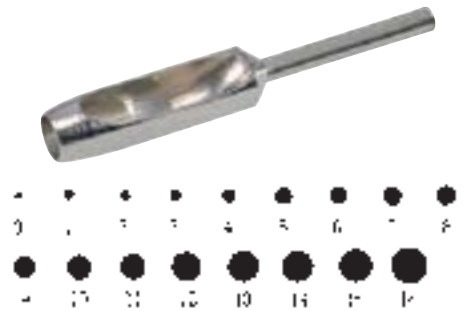

Zierlochnadeln in den Systemen 40 bis 240 sind auf Anfrage lieferbar.
Drive pin punches are available on request for the systems 40 to 240.

system	40	50	60	70	80	90	100	110	120	130	140	150	160	170	180	190	200	210	220	230	240
1																					
2																					
3																					

Halter für Loch- und Zierlochnadeln	063547-000	0,050
--	------------	-------

Holder for special punch head



Patent-Zierlochausschläger	zur Schaftgestaltung, mit Einsatz Nr. 8	063590-000	120	0,130
-----------------------------------	---	------------	-----	-------

Pattern punch for shaft design, with punch head no. 8



Zierlocheinsatz	für Patent-Zierlochausschläger	Nr./no.	
Exchangeable punch head	for pattern punch	063595-001	1, 0,010
		063595-002	2, 0,010
		063595-003	3, 0,010
		063595-005	5, 0,010
		063595-006	6, 0,010
		063595-008	8, 0,010
		063595-010	10, 0,010
		063595-013	13, 0,010
		063595-014	14, 0,010
		063595-015	15, 0,010
		063595-016	16, 0,010
		063595-019	19, 0,010
		063595-024	24, 0,010
		063595-037	37, 0,010

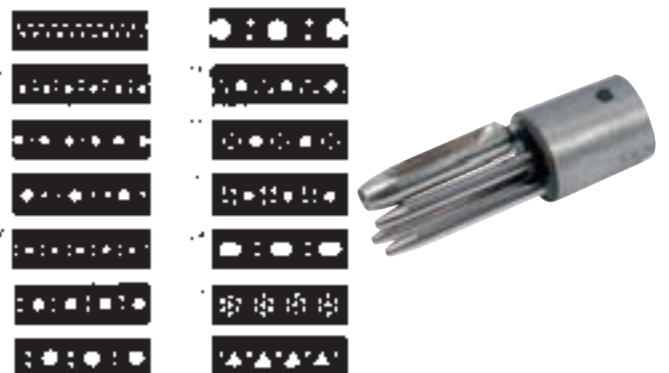

**Spezialwerkzeuge für die
Orthopädie-Schuhtechnik /
Special tools for orthopaedic
shoe technology**



Artikel Article	Beschreibung Description	Artikel-Nr. Code-No.	Länge /mm Length /mm	Gewicht/kg Weight/kg
Kantenschneider	breit, mit Holzheft	063475-001	160	0,045

V-scraper wide,
with wooden handle



Tacksheber	vernickelt, mit Holzheft	063550-100	170	0,080
------------	-----------------------------	------------	-----	-------

Nail puller nickel-plated,
with wooden handle



Klammerzieher	mit Holzheft	063555-000	160	0,070
---------------	--------------	------------	-----	-------

Staple remover with wooden handle



Klammergreifer	zum Entfernen von Heftklammern	064405-000		0,130
----------------	-----------------------------------	------------	--	-------

Staple remover for removing staples



Leistenhaken	zum Ausleisten von Schuhen	063560-000	180	0,130
--------------	-------------------------------	------------	-----	-------

Mold hook for removal of shoe molds

Spezialwerkzeuge für die
Orthopädie-Schuhtechnik/
Special tools for orthopaedic
shoe technology

Artikel Article	Beschreibung Description	Artikel-Nr. Code-No.	Länge /mm Length /mm	Gewicht/kg Weight/kg
Rissöffner	mit Holzheft	063480-000	160	0,050

Channel opener with wooden handle

Schnitteisen	mittelhohe Kante, Schnitt leicht gewölbt, mit Holzheft	Artikel-Nr. Code-No.	Nr. / no.		Gewicht/kg Weight/kg
Setting iron	medium height edge, edge slightly curved, with wooden handle	063415-034	3/4	170	0,090
		063415-056	5/6	170	0,110
		063415-078	7/8	170	0,110
		063415-091	9/10	170	0,110
		063415-112	11/12	170	0,110
		063415-134	13/14	170	0,110
063415-156	15/16	170	0,110		

Spiritus-Ausputzlampe	mit Docht	063700-000	170	0,190
-----------------------	-----------	------------	-----	-------

Kerosene cleaning lamp with wick

Docht	für Spiritus-Ausputzlampe, Meterware	063705-010		0,010
-------	--------------------------------------	------------	--	-------

Wick for kerosene cleaning lamp, yard ware

Modellwinkel	Kunststoff, System "Fachschule Siebenlehn"	063565-000	400	0,100
--------------	--	------------	-----	-------

Special protractor plastic, type "Siebenlehn"

Silbermine	zum Beschriften von Leder, Gummi usw.	063640-000		0,003
------------	---------------------------------------	------------	--	-------

Refill for writing on leather, gum etc.



Spezialwerkzeuge für die Orthopädie-Schuhtechnik / Special tools for orthopaedic shoe technology



Werkzeuge für die Nähtechnik / Tools for sewing technology



Artikel Article	Beschreibung Description	Artikel-Nr. Code-No.	Länge /mm Length /mm	Gewicht/kg Weight/kg
Lederaufrauher	mit Holzheft	060440-000	200	0,160
<i>Leather scratch brush</i>	<i>with wooden handle</i>			
Ersatzkratze	für Lederaufrauher, Code-Nr. 060440-000, mit 4 Ösen	060445-010	100	0,020
<i>Spare scratch card</i>	<i>for leather scratch brush, code no. 60440-000, with 4 eyes</i>			
Lederaufrauher	mit Stahlgriff	060442-000	100	0,130
<i>Leather scratch brush</i>	<i>with steel handle</i>			
Ersatzkratze	für Lederaufrauher, Code-Nr. 060442-000,	060447-000	100	0,050
<i>Spare scratch card</i>	<i>for leather scratch brush, code no. 60442-000,</i>			
Kopierrädchen	mit Stahlnadeln	063610-000	160	0,020
<i>Tracing wheel</i>	<i>with steel needles</i>			
Vorstecher	CV-Stahl, mit Kunststoffheft, Klingenlänge 85 mm	062395-100		0,060
<i>Tracing wheel</i>	<i>CV-steel, with plastic handle, blade length 85 mm</i>			
Reifelh Holz	mit Knochenauflage	062230-000	200	0,070
<i>Grooving wood</i>	<i>with bone plate</i>			

Werkzeuge für die Nähtechnik / Tools for sewing technology

Artikel Article	Beschreibung Description	Artikel-Nr. Code-No.	Länge /mm Length /mm	Gewicht/kg Weight/kg
Falzbein / Spitzknochen		062235-000	160	0,020
<i>Folding bone</i>				
Ahlenheft	mit Ausschlagbolzen, Wasse-Patent	062260-020	80	0,030
<i>Awl handle</i>	<i>with punching bolt, "Wasse" patent</i>			
Nagelheft	mit Schlagring, Bandage und Nietschraube	063650-000	110	0,070
<i>Peg awl handle</i>	<i>with hammer ring and rivet screw</i>			
Nähheft	mit Zwinde und Zangenspannung	063645-000	105	0,040
<i>Sewing awl handle</i>	<i>with clamp and clamp tensioner</i>			
Patentnähheft	zweiteilig	063665-000	110	0,060
<i>Patent sewing awl handle</i>	<i>two parts</i>			
Sattlerahle / Schwertahle	vierkantig	062270-050 062270-060 062270-070	50 60 70	0,020 0,020 0,020
<i>Saddler's awl</i>	<i>square</i>			
Steppahle / Rundahle		062280-050 062280-060 062280-070	50 60 70	0,010 0,010 0,010
<i>Stitching awl</i>				
Sattlernadel	rund, VE = 25 Stück	062290-042 062290-048 062290-054 062290-060 062290-070	42 48 54 60 70	0,010 0,010 0,010 0,010 0,010
<i>Saddler's needle</i>	<i>round box with 25 pcs.</i>			



Schraubzwingen, Klemmen, Kloben / Screw clamps, clamps, hand vises



Artikel Article	Beschreibung Description	Artikel-Nr. Code-No.	Länge /mm Length /mm	Gewicht/kg Weight/kg
Schraubzwin- ge	aus verzinktem Temper- guss, mit beidseitig geriffelter Profilschiene und Holzgriff		Spannweite / jaw width	
		060705-250	250	1,620
		060705-300	300	2,220
		060705-400	400	2,920
060705-600	600	4,600		
Bar clamp	zinc-coated malleable cast iron, with checkered profile rail on both sides, wooden handle			
Feilkloben	gesenkgeschmiedet, Backenbreite 40 mm* 42 mm**	060600-100*	100	0,330
		060600-130**	130	0,520
Hand vise	drop forged, jaw width 40 mm* 42 mm**			
Reifkloben	gesenkgeschmiedet, Backenbreite 40 mm	060605-150	150	0,970
Saw sharpening vise	drop forged, jaw width 40 mm			
Pelottenknopf- kluppe	mit 2 Spannlöchern, zum Annieten von Pelottenknöpfen mit 3 und 4 mm Schaftstärke	060610-070	70	0,190
Stud clamp	with 2 tensioning holes, for riveting pelotte buttons with a shaft thickness of 3 and 4 mm			
Uhrmacher- Stiefelkloben	vernickelt, Backenbreite 16 mm	060615-020	115	0,060
Jeweller's pin vise	nickel-plated, jaw width 16 mm			
Fixklemme	Stahlblech, mit Klemmschutz	062855-110	110	0,050
		062855-155	155	0,160
Fixing clamp	steel plate, with trap protection			

Artikel Article	Beschreibung Description	Artikel-Nr. Code-No.	Ø /mm	Gewicht/kg Weight/kg
Spiralbohrer	HSS, DIN 338, rechtsschneidend, mit zylindrischem Schaft	061400-010	1,0	0,001
		061400-015	1,5	0,001
		061400-020	2,0	0,001
		061400-025	2,5	0,002
		061400-028	2,8	0,002
		061400-030	3,0	0,003
		061400-031	3,1	0,003
		061400-032	3,2	0,004
		061400-035	3,5	0,004
		061400-040	4,0	0,005
Twist drill bit	HSS, DIN 338, right hand cutting, with cylindrical shaft	061400-041	4,1	0,006
		061400-042	4,2	0,006
		061400-045	4,5	0,008
		061400-050	5,0	0,009
		061400-055	5,5	0,012
		061400-060	6,0	0,014
		061400-065	6,5	0,018
		061400-070	7,0	0,023
		061400-075	7,5	0,025
		061400-080	8,0	0,030
		061400-085	8,5	0,035
		061400-090	9,0	0,040
		061400-095	9,5	0,045
		061400-100	10,0	0,055

Spiralbohrersatz	HSS, DIN 338, rechtsschneidend, mit zylindrischem Schaft, in Stahlblechkassette	061720-110*		0,750
		061720-113**		1,360
		061720-159***		0,660

Set of twist drill bits HSS, DIN 338,
right hand cutting,
with cylindrical shaft,
in metal case,
19 pcs., 1 - 10 mm*
25 pcs., 1 - 13 mm**
50 pcs., 1 - 5,9 mm***

Spiralbohrer	HSCO, DIN 338, rechtsschneidend, mit zylindrischem Schaft, zum Bohren von rost- freiem Stahl und Feder- bandstahl	061630-020	2,0	0,001
		061630-030	3,0	0,003
		061630-031	3,1	0,004
		061630-032	3,2	0,004
		061630-035	3,5	0,004
		061630-040	4,0	0,006
		061630-041	4,1	0,006
Twist drill bit	HSCO, DIN 338, right hand cutting, with cylindrical shaft, for stainless steel and spring band steel	061630-042	4,2	0,007
		061630-045	4,5	0,007
		061630-050	5,0	0,009

Zentrierbohrer	HSS, DIN 338, rechtsschneidend, Senkwinkel 60°	061725-315	3,15	0,010
-----------------------	--	------------	------	-------

Center drill HSS, DI 338,
right hand cutting,
angle 60°

Forstnerbohrer/ Astlochbohrer	für Holzbearbeitung, rechtsschneidend, mit zylindrischem Schaft	061750-014	14	0,090		
		061750-015	15	0,090		
		061750-018	18	0,100		
		061750-020	20	0,100		
		061750-022	22	0,100		
		061750-024	24	0,120		
		061750-025	25	0,120		
		Forstner bit	for wood working, right hand cutting, with cylindrical shaft	061750-026	26	0,120
				061750-028	28	0,130
				061750-030	30	0,140
061750-038	38			0,220		
061750-040	40			0,220		
061750-042	42	0,220				

Forstnerbohrersatz	11-teilig, im Holzständer	061755-000	14 - 38	2,200
---------------------------	------------------------------	------------	---------	-------

Forstner bit set 11 pcs.,
in wooden stand



Andere Abmessungen auf Anfrage lieferbar.
Other dimensions are available on request.

**Bohrer, Gewindebohrer /
Drill bits, taps**



Artikel Article	Beschreibung Description	Artikel-Nr. Code-No.	Ø /mm	Gewicht/kg Weight/kg
Schälbohrer	HSS, für Kunststoffbearbeitung	061730-314	14	0,020
		061730-820	20	0,050
		061730-935	30	0,120
		061730-940	40	0,270
Drill	HSS, for plastic working			
Kegelsenker	HSS, Senkwinkel 90°, dreischneidig	061660-013	12	0,020
Countersink	HSS, angle 90°, three cutters			
Ventilsitzfräser	für Gummi­flachventile, Schaft-Ø 10 mm, Ø 27 mm für Ventilsitz	063280-427	40	0,180
Valve seat cutter	for flat rubber valves, shaft Ø 10 mm, valve body seat Ø 27 mm			
Handgewindebohrersatz	HSS, bestehend aus Vor-, Mittel- und Fertigschneider, in Kunststoffbox	061000-030	M3	0,020
		061000-040	M4	0,020
		061000-050	M5	0,030
		061000-060	M6	0,030
		061000-070	M7	0,030
		061000-080	M8	0,060
Hand tap set	HSS, one each taper, plug and bottoming tap, in plastic box	061000-090	M9	0,060
		061000-100	M10	0,090
Handmuttergewindebohrer	HSS, Fertigschneider,	061010-030	M3	0,010
		061010-050	M5	0,010
Taps	HSS, bottoming tap			
Werkzeughalter mit Knarre	Rechts-/Linksgang, Ganzstahlausführung, für Gewindebohrer M3 - M10	061015-000		0,180
Tap holder with ratchet	for right- and left-hand-turn, all steel quality, for M3 - M10			

Andere Abmessungen auf Anfrage lieferbar.
Other dimensions are available on request.

Schneideisen, Reibahlen / Round dies, reamer

Artikel Article	Beschreibung Description	Artikel-Nr. Code-No.	Ø /mm	Gewicht/kg Weight/kg
Windeisen	verstellbar, mit gehärteten Backen	061020-000	M1 - M8	0,050
		061020-001	M1 - M10	0,090

Tap wrench adjustable,
with hardened jaws



Gewinde- schneideisen	HSS	Außen-Ø/ mm External-Ø/ mm		Gewicht/kg
		Ø	Thread	
Round die	HSS	061030-030	20 M3	0,010
		061030-035	20 M3,5	0,010
		061030-040	20 M4	0,010
		061030-045	20 M4,5	0,010
		061030-050	20 M5	0,010
		061030-060	20 M6	0,010
		061030-070	25 M7	0,020
		061030-080	25 M8	0,020
		061030-090	25 M9	0,020
		061030-100	30 M10	0,030



Schneideisenhalter	061040-034	M3 - M4	0,070
	061040-056	M5 - M6	0,070
	061040-079	M7 - M9	0,120
	061040-101	M10 - M11	0,250

Stock for round dies



Gewindeschneid- werkzeugsatz	HSS, 27-teilig, M3 - M10, mit Windeisen, Schneideisenhalter, in Blechkassette	061060-000		3,800
---	---	------------	--	-------

Taps HSS,
27 pcs., M3 - M10,
with adjustable tap wrench,
stocks for round dies,
in metal case



Handreibahle	HSS, rechtsschneidend, mit zylindrischem Schaft und Vierkant, spiralgenutet	062000-050	5,0	0,010
		062500-055	5,5	0,010
		062000-060	6,0	0,020
		062000-065	6,5	0,020
		062000-070	7,0	0,020
		062000-075	7,5	0,030
		062000-080	8,0	0,030
Hand reamer	HSS, right hand cutting, with cylindrical shaft and square, spiral flute	062000-085	8,5	0,050
		062000-090	9,0	0,050
		062000-095	9,5	0,050
		062000-100	10,0	0,060
		062000-105	10,5	0,060
		062000-110	11,0	0,080
		062000-120	12,0	0,110
		062000-125	12,5	0,110
		062000-130	13,0	0,120
		062000-140	14,0	0,150
062000-150	15,0	0,180		
062000-160	16,0	0,230		

Langmesser- reibahle	HSS, rechtsschneidend	062030-135	13,5 - 15,5	0,140
		062030-158	15,5 - 17,5	0,210

Expansion reamer HSS, right hand cutting



**Pinsel, Behälter, Bürsten/
Brushes, glue containers**



Artikel Article	Beschreibung Description	Artikel-Nr. Code-No.	Ø /mm Breite/mm Width/mm	Größe/ size	Gewicht/kg Weight/kg
Pinsel	reine Chinaborsten, Ringpinsel*	012030-020*	Ø 20	2	0,020
	Flachpinsel**	012030-030*	Ø 30	6	0,040
	Fugenpinsel, angewinkelt***	012030-035*	Ø 35	8	0,050
		012030-110**	10	10	0,015
Brush	pure chinese bristles, ring brush*	012030-120**	20	20	0,030
	flat brush**	012030-230***	30		0,070
	flat brush, angled***				
Emaillackpinsel	helle Naturborsten	012030-300	25	5	0,050
<i>Enamel paintbrush light natural bristles</i>					
Sparbehälter/ TS-boy	für Klebstoff, mit Pinsel und Verschlusskappe Inhalt 0,450 l* 0,900 l** 1,500 l***	062900-045*			0,120
		062900-090**			0,250
		062900-150***			0,290
Economy glue container/TS-boy	for glues, with brush and cover contents 0,450 l* 0,900 l** 1,500 l***				
Ersatzpinsel	rund, für Code-Nr. 062900-045* für Code-Nr. 062900-090 und 062900-150**	062905-045*			0,010
		062905-159**			0,030
Spare brush	round, for code-no. 062900-045* for code-no. 062900-090 and 062900-150**				
Talkumstreuer	Kunststoff, Inhalt ca. 0,200 l	026880-000			0,050
Talcum dispenser	plastic, contents approx. 0,200 l				
Ölspritzkanne	Kunststoff, Inhalt ca. 0,250 l	062870-250			0,060
Oil can	plastic, contents approx. 0,250 l				
Stahldrahtbürste	Länge 280 mm	060430-000			0,120
Wire scratch brush	length 280 mm				
Feilenbürste	Länge 230 mm	060450-230			0,080
File brush	length 230 mm				

Schutzausrüstung / Protective equipment

Artikel Article	Beschreibung Description	Artikel-Nr. Code-No.	Länge/mm Length/mm	Größe/ size	Gewicht/kg Weight/kg
Wärmeschutz- handschuh	Baumwoll-Schlingen- handschuh, mit Stulpen* mit Strickbund** aus Baumwoll-Trikot***	062895-000*	300		0,240
		062890-030**	250		0,170
		062897-000***	230		0,060
Protective gloves	<i>Cotton, with cuffs* with knitted trim** cotton tricot***</i>				
Schnittschutz- handschuh	Kevlar-Handschuhe, mit Latex-Beschichtung für guten Griff, handrückenfrei, mit Strickbund	062891-000		10	0,200
Cut protection gloves	<i>Kevlar gloves, latex coated, overhand free, with knitted trim</i>				
Schutzhandschuh	dünnes Leder	062890-010		10	0,070
Protective gloves	<i>thin leather</i>				
Arbeitshandschuh	Leder/Stoff* Leder mit Stulpen, für Schweissarbeiten**	062890-020*	260		0,150
		062890-025**	340		0,270
Work gloves	<i>leather/cloth* leather with cuffs**</i>				
Einweghandschuhe	aus PE-Folie*,	062885-000*	10		0,200
	aus Latex**, für Gipsarbeiten, leicht gepudert, mit Rollrand, nicht steril, VE = 100 Stück	062885-010**	7		0,530
		062885-020**	8		0,530
Disposable gloves	<i>PE film*, latex**, for plaster working, lightly powdered, not sterile, packaging unit = 100 pcs.</i>				



Schutzausrüstung /
Protective equipment



Artikel Article	Beschreibung Description	Artikel-Nr. Code-No.	Größe/mm size/mm	Gewicht/kg Weight/kg
Gippschürze	Kunststoff-Schürze mit eingeschweissten PVC-Ösen, Seiten- und Nackenbändern, säure- und laugenbeständig	062810-000		0,820
Plaster apron	plastic apron with sealed PVC eyelets, side and neck straps, acid and alkaline resistant			
Schweisserschürze	aus Chromkernspaltleder, mit Lederriemen	062805-000	800x1000	0,600
Welder's apron	chrome leather, with straps			
Schweisser- schutzschild	mit Glas	062872-000		0,360
Welder's face protector	with glass			
Schutzbrille	Kunststoff, mit splitterfreiem Verbundglas, längenverstellbaren Bügeln, umklappbarem Seitenschutz	025690-000		0,060
Safety glasses	plastic, shatterproof laminated safety glass, length-adjustable sides, folding side protection			
Ersatzgläser	für Schutzbrille, Code-Nr. 025690-000	025692-000		0,010
Spare glasses	for safety glasses, code-no. 025690-000			
Staubfiltermaske	Einweg-Feinstaubmaske, Schadstoffklasse FFP1, geprüft nach EN149:2001, ohne Ventil, VE = 20 Stück	062875-010		0,007
Dust filter mask	disposable dust filter mask, pollutant class FFP1, certified acc. to EN 149:2001, without valve packaging unit = 20 pcs.			
Mundschutz	Einweg-Mundschutz gegen grobe, ungefährliche Partikel, VE = 50 Stück	062875-020		0,005
Mouth protection	disposable mouth protection for protection against coarse, non-hazardous particles, packaging unit = 50 pcs.			
Kombinations- Atemschutzmaske	Typ Combitox Nova, Halbmaske, besonders hautfreundlich, zum Einsatz mit Partikelfiltern, Gas- und Kombifiltern mit Rundgewinde Rd 91, geprüft nach EN140, ohne Filter	062876-000		0,300
Combination respirator mask	type "Combitox Nova", half mask, particularly kind to the skin, for use with particulate filters, gas and combination filters with round thread Rd 91, certified acc. to EN 140, without filter			

Schutzausrüstung / Protective equipment

Artikel Article	Beschreibung Description	Artikel-Nr. Code-No.	Gewicht/kg Weight/kg
Grobstaubfilter	Vorfilter für Filter mit Rundgewinde Rd 91, VE = 10 Stück	062877-000	0,020
<i>Coarse dust filter</i>	<i>prefilter for filter with round thread Rd 91, packaging unit = 10 pcs.</i>		
Kombinationsfilter	Schraubfilter mit Rundgewinde Rd 91, Partikelfilterklasse A1-P2	062878-000	0,110
<i>Combination filter</i>	<i>screw filter with round thread Rd 91, particulate filter class A1-P2</i>		
Kapselgehörschutz	stufenlos höhenverstellbar, für starke Lärmbelastigung geeignet	062880-000	0,190
<i>Ear protectors</i>	<i>with infinite height adjustment, suitable for loud volumes</i>		
Gehörschutzstöpsel	aus weichem, schallabsorbierendem Schaumstoff, VE = 5 Paar	062882-000	0,020
<i>Ear plugs</i>	<i>made of soft, sound-absorbing foam, packaging unit = 5 pairs</i>		
Betriebsverbandkasten	klein, nach DIN 13157 C, für Verarbeitungsbetriebe mit bis zu 20 Versicherten, mit Wandhalterung	R49970301	1,080
<i>First aid kit for companies</i>	<i>compact, acc. to DIN 13157 C, for processing companies with up to 20 insured employees, with wall mounting</i>		
Ersatz-Füllung	kompletter Inhalt von Code-Nr. R49970301, 63-teilig, in Folientasche	R49970305	0,700
<i>Replacement contents</i>	<i>complete contents of code no. R49970301, 63 pcs., in plastic wallet</i>		
Ersatz-Füllung	Austausch-Sortiment der Steril-Materialien von Code-Nr. R49970301, 14-teilig, in Folientasche	R49970307	0,150
<i>Replacement contents</i>	<i>selection of replacement sterile materials of code no. R49970301, 14 pcs., in plastic wallet</i>	Inhalt nach DIN 13157 3 Verbandpäckchen DIN 13151-M 1 Verbandpäckchen DIN 13151-G 1 Verbandpäckchen DIN 13151-K 1 Verbandtuch DIN 13152-A 60 x 80 cm 6 Wundkompressen 10 x 10 cm 2 Augenkompressen, einzeln steril	<i>Contents acc. to DIN 13157 3 compression bandages DIN 13151-M 1 compression bandage DIN 13151-G 1 compression bandage DIN 13151-K 1 sterial gauzes DIN 13152-A 60 x 80 cm 6 wound compresses 10 x 10 cm 2 eye compresses, sterile</i>
Betriebsverbandkasten	groß, nach DIN 13169, für Verarbeitungsbetriebe mit 21 bis 100 Versicherten, ohne Wandhalterung	R49970310	5,180
<i>First aid kit for companies</i>	<i>large, acc. to DIN 13169, for processing companies with 21 to 100 insured employees, without wall mounting</i>		
Wandhalterung	Stahlblech, für Code-Nr. R49970310	R49970312	0,740
<i>Wall mounting</i>	<i>steel plate, for code no. R49970310</i>		
Ersatz-Füllung	kompletter Inhalt von Code-Nr. R49970310, 127-teilig, in Folientasche	R49970315	1,340
<i>Replacement contents</i>	<i>complete contents of code no. R49970310, 127 pcs., in plastic wallet</i>		
Ersatz-Füllung	Austausch-Sortiment der Steril-Materialien von Code-Nr. R49970310, 28-teilig, in Folientasche	R49970317	0,280
<i>Replacement contents</i>	<i>selection of replacement sterile materials of code no. R49970310, 28 pcs., in plastic wallet</i>	Inhalt nach DIN 13169 6 Verbandpäckchen DIN 13151-M 2 Verbandpäckchen DIN 13151-G 2 Verbandpäckchen DIN 13151-K 2 Verbandtuch DIN 13152-A 60 x 80 cm 12 Wundkompressen 10 x 10 cm 4 Augenkompressen, einzeln steril	<i>Contents acc. to DIN 13169 6 compression bandages DIN 13151-M 2 compression bandage DIN 13151-G 2 compression bandage DIN 13151-K 2 sterial gauzes DIN 13152-A 60 x 80 cm 12 wound compresses 10 x 10 cm 4 eye compresses, sterile</i>



Maschinen-Werkzeuge /
Tools for machines



Artikel Article	Beschreibung Description	Artikel-Nr. Code-No.	Gewinde Thread	Ø / mm	Gesamtlänge/mm Total length/mm	Gewicht/kg Weight/kg
Gewindebolzen mit zyl. Passung	passend für Artikel 075000-000, 075015-000 und 075005-000	063270-016	M16			0,200
		063270-058	5/8"			0,200
<i>Threaded stud with cyl. clearance</i>		<i>fits articles 075000-000, 075015-000 and 075005-000</i>				



Gewindebolzen	passend für Artikel 075031-000 und 075033-000	063271-016	M16			0,140
		063271-058	5/8"			0,140
<i>Threaded stud</i>		<i>fits articles 075031-000 and 075033-000</i>				



Gewinde- übergangsstück		Innengewinde Inside thread		Aussengewinde outside thread		Gewicht/kg Weight/kg
		Artikel-Nr. Code-No.	Gewinde Thread	Ø / mm	Gesamtlänge/mm Total length/mm	
<i>Thread adapter</i>		063250-165	M16	5/8"		0,180
		063250-516	5/8"		M16	0,180



Kugelfräser	mit auswechselbarem Messers	063210-016	M16	38	90	0,320
		063210-058	5/8"	38	90	0,320
		063210-516	M16	50	100	0,510
		063210-558	5/8"	50	100	0,510
<i>Ballhead cutter</i>		<i>with replaceable blade</i>				



Ersatzmesser für Kugelfräser	für Code-Nr. 063210-016/-058; HSS 063210-516/-558; HSS	063215-000	38			0,030
		063215-050	50			0,040
<i>Replacement blade for ballhead cutter</i>		<i>for code no. 063210-016/-058; HSS 063210-516/-558; HSS</i>				



Messerfräser	mit 2 auswechselbaren Messern	063200-116		50	90	0,650
		063200-158		50	90	0,650
<i>Knife milling tool</i>		<i>with 2 replaceable blades</i>				

Ersatzmesser für Fräser	für Code-Nr. 063200-116/-158; HSS	063205-100		50	90	0,040
		<i>Replacement blade for milling cutter</i>				
		<i>for code no. 063200-116/-158; HSS</i>				

Maschinen-Werkzeuge / Tools for machines

Artikel Article	Beschreibung Description	Artikel-Nr. Code-No.	Gewinde Thread	Ø / mm	Gesamtlänge/mm Total length/mm	Gewicht/kg Weight/kg
Raspelkordelband- fräser	mittel (Hieb 2) für Nuten 20 mm breit und 2,5 mm tief	063050-016	M16	50		0,350
		063050-058	5/8"	50		0,350

**Rasp cord tape
milling tool** *medium (stroke 2)
for grooves 20 mm wide
and 2,5 mm deep*

Raspelfräser	mittel (Hieb 2) für Holz und Schaumstoff	063100-116	M16	50	100	1,060	1
		063100-158	5/8"	50	100	1,060	2
		063100-216	M16	50	80	0,640	3
		063100-258	5/8"	50	80	0,640	4
		063100-316	M16	30	105	0,320	5
Rasp milling tool	<i>medium (stroke 2) for wood and foam</i>	063100-358	5/8"	30	105	0,320	1
		063100-416	M16	35	55	0,240	2
		063100-458	5/8"	35	55	0,240	3
		063100-516	M16	45	110	0,770	4
		063100-558	5/8"	45	110	0,770	5

Raspelfräser	fein (Hieb 3) für Kunststoff	063110-116	M16	50	100	1,150	1
		063110-158	5/8"	50	100	1,150	2
		063110-316	M16	30	105	0,350	3
		063110-358	5/8"	30	105	0,350	4
		063110-416	M16	35	55	0,240	5
Rasp milling tool	<i>fine (stroke 3) for plastic</i>	063110-458	5/8"	35	55	0,240	1
		063110-516	M16	45	110	0,970	2
		063110-558	5/8"	45	110	0,970	3



Maschinen-Werkzeuge /
Tools for machines



Artikel Article	Beschreibung Description	Artikel-Nr. Code-No.	Gewinde Thread	Ø / mm	Gesamtlänge/mm Total length/mm	Gewicht/kg Weight/kg
Kantenfräser	für Metall; HSS, bis Materialstärke 1,75 mm* 2,00 mm** 2,25 mm***, Innen-Ø 90 mm	063000-917*				0,460
		063000-920**				0,460
		063000-922***				0,460
Edge cutter	for metal; HSS up to material thickness 1,75 mm* 2,00 mm** 2,25 mm***, Inner-Ø 90 mm					
Aufnahme für Kantenfräser		063001-016	M16			0,260
Fixture for edge cutter						
Walzenfräse	HSS,	063020-016	M16	50	50	0,750
		063020-058	5/8"	50	50	0,750
Plain milling cutter	HSS					
Feinfräser, HSS	spiralverzahnt, für Aluminium und Kunststoffe	063040-016	M16	27	70	0,130
		063040-058	5/8"	27	70	0,130
Fine milling cutter, HSS	spiral-toothed, for aluminium and plastics					
Schleifwalze	zum Aufschieben auf die Welle der Trichter- fräsmaschine, mit einer Schleifhülse, Korn 80	064075-200	M16	200	72,5	0,320
Sanding drum	for sliding onto the shaft of the socket router, with a sanding sleeve, grain 80					
Schleifhülse	für Code-Nr. 064075-200		Körnung Grain			
		064078-024	24	200	72,5	0,080
Sanding sleeve	for code no. 064075-200	064078-039	40	200	72,5	0,080
		064078-040	50	200	72,5	0,080
		064078-060	60	200	72,5	0,080
		064078-080	80	200	72,5	0,080
		064078-100	100	200	72,5	0,080
Konusfeinputzer		064095-116	M16	45	75	0,480
		064095-158	5/8"	45	75	0,480
		064095-216	M16	60	75	0,570
		064095-258	5/8"	60	75	0,570
Cone fine cleaner						

Maschinen-Werkzeuge / Tools for machines

Artikel Article	Beschreibung Description	Artikel-Nr. Code-No.	Gewinde Thread	Ø / mm	Gesamtlänge/mm Total length/mm	Gewicht/kg Weight/kg
Halter für Konusfeinputzer	ohne Spannschraube	064096-116	M16			0,360
		064096-158	5/8"			0,360

*Holder for
cone fine cleaner*
without tensioning screw



Spannschraube für Konusfeinputzer		064098-040	M8	8	40	0,020
--------------------------------------	--	------------	----	---	----	-------

*Tensioning screw
for cone fine cleaner*



Gummikörper für Konusfeinputzer		064097-457		45	75	0,070
		064097-607		60	75	0,165

*Rubber roll for
cone fine cleaner*



Schleifhülse	Leinengewebe, Kunstharzbindung, für Konusfeinputzer	Körnung Grain					
<i>Sanding sleeve</i>	<i>Linen cloth, synthetic resin bond, for cone fine cleaner</i>	24	45	75	0,020		
		064100-024	40	45	75	0,020	1
		064100-040	60	45	75	0,020	2
		064100-060	80	45	75	0,020	
		064100-080	100	45	75	0,020	
		064100-100	120	45	75	0,020	
		064100-120	240	45	75	0,020	
		064100-240	24	60	75	0,020	
		064110-024	40	60	75	0,020	
		064110-040	60	60	75	0,020	
		064110-060	80	60	75	0,020	
		064110-080	100	60	75	0,010	
		064110-100	120	60	75	0,010	
		064110-120	240	60	75	0,010	

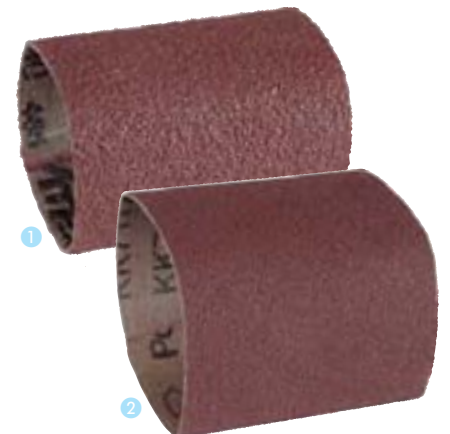

Schleifwalze	zylindrisch	064040-100	5/8"	100	100	0,470	1
		064040-025	5/8"	25	50	0,470	2
		064040-045	5/8"	45	75	0,470	3
		064040-060	5/8"	60	75	0,470	4

Sanding drum
cylindrical

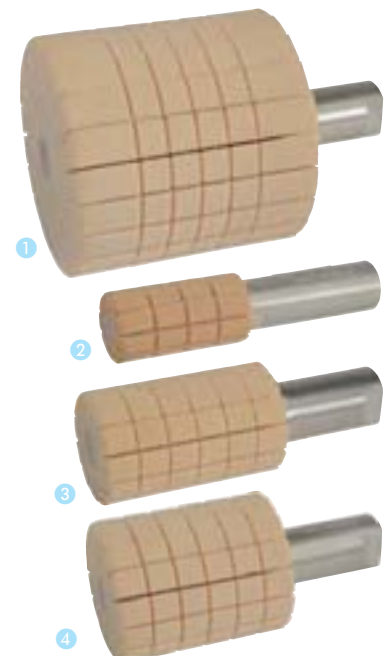

Maschinen-Werkzeuge /
Tools for machines

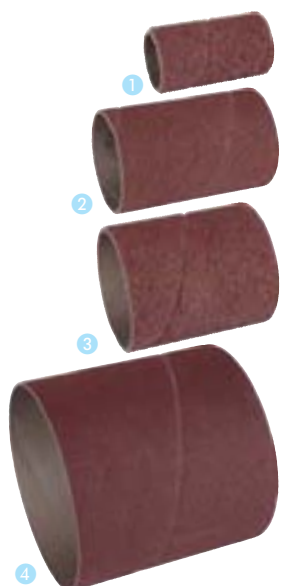

Artikel Article	Beschreibung Description	Artikel-Nr. Code-No.	Gewinde Thread	Ø / mm	Gesamtlänge/mm Total length/mm	Gewicht/kg Weight/kg
Schleifhülse	Leinengewebe, Kunstharzbindung, für zylindrische Schleifwalze	Körnung Grain				
		① 064041-040	40	25	50	0,020
		064041-080	80	25	50	0,020
		064041-120	120	25	50	0,020
Sanding sleeve	Linen cloth, synthetic resin bond, for cylindrical sanding drum	① 064041-240	240	25	50	0,020
		064042-040	40	45	75	0,020
		② 064042-080	80	45	75	0,020
		064042-120	120	45	75	0,020
		③ 064043-040	40	60	75	0,020
		064043-080	80	60	75	0,020
		064043-120	120	60	75	0,020
		④ 064044-040	40	100	100	0,020
064044-080	80	100	100	0,020		
064044-120	120	100	100	0,020		
064044-240	240	100	100	0,020		

Feinputzer nach Habermann	mit 1 Feinputzband, Gr. 1* Gr. 2** Gr. 3*** Gr. 4****	① 064000-116*	M16	46	58	0,340
		064000-158*	5/8"	46	58	0,340
		② 064000-216**	M16	60	58	0,420
		064000-258**	5/8"	60	58	0,420
Habermann fine cleaner	with 1 fine cleaning tape, size 1* size 2** size 3*** size 4****	③ 064000-316***	M16	60	100	0,650
		064000-358***	5/8"	60	100	0,650
		④ 064000-416****	M16	85	58	0,710
		064000-458****	5/8"	85	58	0,710

Feinputzerband	für Habermann Feinputzer, Gr. 1* Gr. 2** Gr. 3*** Gr. 4****	Artikel-Nr.	Körnung Grain	Ø / mm	Gesamtlänge/mm	Gewicht/kg
Fine cleaning tape	for Habermann fine cleaner, size 1* size 2** size 3*** size 4****	① 064050-101*	60	45	58	0,015
		064050-102*	100	45	58	0,015
		064050-103*	150	45	58	0,015
		② 064050-201**	60	60	58	0,015
		064050-202**	100	60	58	0,015
		064050-203**	150	60	58	0,015
		③ 064050-301***	60	60	100	0,015
		064050-302***	100	60	100	0,015
		064050-303***	150	60	100	0,015
		④ 064050-401****	60	85	58	0,020
		064050-402****	100	85	58	0,020
		064050-403****	150	85	58	0,020

verstellbarer Stirnloch-Schlüssel	für Habermann- Feinputzer, Zapfen-Ø 3 mm	064051-000	3	0,120
--	---	------------	---	-------

Adjustable face pin wrench for Habermann fine cleaner, stud Ø 3 mm

Maschinen-Werkzeuge / Tools for machines

Artikel Article	Beschreibung Description	Artikel-Nr. Code-No.	Gewinde Thread	Ø / mm	Gesamtlänge/mm Total length/mm	Gewicht/kg Weight/kg
Stirnputzer mit Aufnahme	mit Gummispannkörper	064052-016	M16	11		0,140
		064052-058	5/8"	11		0,140
		064053-016	M16	16		0,140
		064053-058	5/8"	16		0,140
		064054-016	M16	21		0,140
064054-058	5/8"	21		0,140		
Face cleaner with fixture	with rubber chuck cone					
Schleifhütchen	für Stirnputzer Code-Nr. 064052-*			Körnung Grain		
		064053-**	067965-010*	60		0,005
		064054-***	067965-015*	280		0,005
			067965-020**	60		0,005
			067965-025**	280		0,005
			067965-030***	60		0,005
	067965-035***	280		0,005		
Sanding cap	for face cleaner code no. 064052-*					
	064053-**					
	064054-***					
Schleifwalze	klein	064080-158	5/8"	25	100	0,150
Sanding drum	small					
Schleifhülse	klein, für Code-Nr. 064080-158			Körnung Grain		
		064085-040	50	25	50	0,005
		064085-150	150	25	50	0,005
Sanding sleeve	small, for code no. 064080-158					
Kegelschleifer		064020-016	M16	24	36 x 60	0,200
		064020-058	5/8"	24	36 x 60	0,200
Cone grinder						
Schleifhülse für Kegelschleifer	für Code-Nr. 064020			Körnung Grain		
		064025-010	50	24	36 x 60	0,005
		064025-020	150	24	36 x 60	0,005
Grinder sleeve for cone grinder	for code no. 064020					
Schleifwalze	mit Gummidecke und Innensechskantschlüssel	064290-016	M16	90	100	0,550
		064290-058	5/8"	90	100	0,550
		064290-660	M16	60	100	0,350
		064290-980	5/8"	60	100	0,350
Grinder sleeve for cone grinder	with rubber cover and hex key					



Schleifblätter und Schleifbandrollen passend zu Schleifwalzen,
064290- erhältlich.
Sandpaper and sanding belt rolls fitting sanding drums,
064290- available.

Maschinen-Werkzeuge /
Tools for machines



Artikel Article	Beschreibung Description	Artikel-Nr. Code-No.	Gewinde Thread	Ø / mm	Gesamtlänge/mm Total length/mm	Gewicht/kg Weight/kg
Fächer Schleifvlieswalze	Körnung 150	064011-000	M6	60	50	0,090

Fan sanding fleece drum grain 150



Schleifvlieswalze	Körnung 180	064012-000	M6	60	50	0,090
-------------------	-------------	------------	----	----	----	-------

Sanding fleece drum grain 180



Aufnahme, konisch	für Schleifvlieswalzen	064013-058	5/8"/M6	16	80	0,130
		064013-016	M16/M6	16	80	0,130

Fixture, conical for sanding fleece drums



Stirnputzer		① 064030-016	M16	65	90	0,220
		064030-058	5/8"	65	90	0,220
		② 064030-916	M16	45	70	0,110
		064030-958	5/8"	45	70	0,110

Face cleaner



Schleifhütchen	für Stirnputzer		Körnung Grain			
Schleifhütchen	für Stirnputzer		① 064035-010	40	65	0,040
			064035-020	80	65	0,040
			② 064035-910	40	45	0,020
			064035-920	80	45	0,020

Sanding cap for face cleaner



Filzschleifkegel	für Beileimung mit Flint	① 063115-116	M16	45	60	0,060
		063115-158	5/8"	45	60	0,060
		② 063115-216	M16	55	75	0,100
		063115-258	5/8"	55	75	0,100
		③ 063115-316	M16	65	85	0,140
		063115-358	5/8"	65	85	0,140
		④ 063115-416	M16	80	100	0,210
		063115-458	5/8"	80	100	0,210

Felt polishing cone for gluing with flint

Maschinen-Werkzeuge /
Tools for machines

Artikel Article	Beschreibung Description	Artikel-Nr. Code-No.	Gewinde Thread	Ø / mm	Gesamtlänge/mm Total length/mm	Gewicht/kg Weight/kg
Flint			Körnung Grain			
		064190-030	30			1,000
		064190-060	60			1,000



Flint						
Rotleim, flüssig	Vorleim für Flint	011634-000				1,000

Glue, liquid primer for bonding grit



Rotleim-Elastik	Nachleim für Flint	011634-001				1,000
Elastic glue	Glue for bonding grit					

Schleifmop	für Feinschliff, Bohrung 16 mm Ø, mit Spanndeckel	Artikel-Nr. Code-No.	Körnung Grain	Ø / mm	Gesamtlänge/mm Total length/mm	Gewicht/kg Weight/kg
		064087-001	280	150	25	0,400

Sanding mop for lapping, 16 mm Ø bore, with clamping cover



Spanndeckel für Schleifmop		064088-000		79	16	0,130
----------------------------	--	------------	--	----	----	-------

Clamping cover for sanding mop



Gummischleifkegel	zur Kunststoffbearbeitung	064070-050	5/8"	50	80	0,250
		064070-060	5/8"	60	90	0,340
		064070-070	5/8"	70	100	0,490
		064070-150	M16	50	80	0,250
		064070-160	M16	60	90	0,340
		064070-170	M16	70	100	0,490

Rubber grinding cone for processing plastics



Maschinen-Werkzeuge /
Tools for machines



Artikel Article	Beschreibung Description	Artikel-Nr. Code-No.	Gewinde Thread	Ø / mm	Gesamtlänge/mm Total length/mm	Gewicht/kg Weight/kg
Schmirgelschwabbel		064005-016	M16	58	58	0,360
		064005-058	5/8"	58	58	0,360

Polishing / buffing cleaner



Schleifblattsatz für Schmirgelschwabbel	für Code-Nr. 064005-016/-058, Körnung 120	064007-000				0,010
---	---	------------	--	--	--	-------

Sandpaper set for polishing / buffing cleaner for code no. 064005-016/-058, grain 120

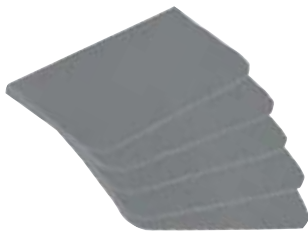

Gummischeibensatz	für Code-Nr. 064005-016/-058,	064009-000				0,040
-------------------	-------------------------------	------------	--	--	--	-------

Set of rubber disks for code no. 064005-016/-058,



Schleiffräser	für Schaumstoffbearbeitung	064060-058	5/8"	70	135	0,500
---------------	----------------------------	------------	------	----	-----	-------

Grinding cutter for processing foam



Stahldraht-Rundbürste	Bohrung 16 mm Ø, zur Schaumstoff-Bearbeitung, Breite 30 mm	064090-150		150		0,840
-----------------------	--	------------	--	-----	--	-------

Steel-wire round brush bore 16 mm Ø, for processing foam, width 30 mm

Maschinen-Werkzeuge /
Tools for machines

Artikel Article	Beschreibung Description	Artikel-Nr. Code-No.	Gewinde Thread	Ø / mm	Breite/mm width/mm	Gewicht/kg Weight/kg
Polierscheibe	Nessel, Bohrung 16 mm Ø, 1 Steppring	064350-110		150	25	0,450
		064350-123		180	30	0,450

Polishing wheel
Untreated cotton cloth
folded in waves,
bore 16 mm Ø,
1 step ring



Polierscheibe	Nessel, Bohrung 16 mm Ø, 3 Steppringe	064350-223		250	30	0,950
---------------	---	------------	--	-----	----	-------

Polishing wheel
Untreated cotton cloth
folded in waves,
bore 16 mm Ø,
3 step rings

Weitere Abmessungen auf Anfrage.
Other dimensions on request.

Spezial- Polierscheibe	aus Nesselgewebe, Wellenfaltung, Bohrung 15 mm geeignet für die Kunststoffbearbeitung	064351-000		200	20	0,250
---------------------------	---	------------	--	-----	----	-------

*Special
polishing wheel*
made of untreated cotton
cloth folded in waves,
bore 15 mm,
suitable for processing plastics



Lamellen- Schleifscheibe	Schleifvlies, Bohrung 16 mm	064010-100		100	50	0,180
		064010-200		200	50	0,730

*Flap sanding
wheel*
Sanding fleece,
16 mm bore

Werkzeug-Aufnahme für alle gängigen Maschinen lieferbar!
Tool holders for all common machines available!



Aufnahme für Lappen-und Polierscheibe		064351-058	5/8"			0,310
		064351-016	M16			0,310

Fixture for cloth and polishing wheels





Germany since 1879

SCHEIN ORTHOPÄDIE SERVICE KG

Postfach 11 06 09

D-42866 Remscheid
Germany

Tel. +49(0) 21 91 / 910-0 Fax +49(0) 21 91 / 910-100

E-mail: info@schein.de Internet: www.schein.de